

IndAmb®

INDUSTRIJSKA AMBALAŽA



KATALOG INDUSTRIJSKIH PROIZVODA

www.industrijskaambalaza.com



PLASTIČNE KUTIJE ZA TRANSPORT I SKLADISTENJE

3 - 29

PLASTIC CARRYING CRATES

PLASTIČNE KUTIJE

3 - 16

PLASTIC CRATES

SKLOPIVE PLASTICNE KUTIJE

18 - 19

FOLDING CRATES



KONUSNE KUTIJE

20 - 21

NESTABLE CRATES

BOX PALETE

24 - 27

CONTAINERS

SKLOPIVE BOX PALETE

28 - 29

FOLDING CONTAINERS



PLASTIČNE PALETE

30 - 33

PLASTIC PALLETS



ESD ANTISTATIČKE KUTIJE

34 - 37

ESD CONDUCTIVE PRODUCTS



KONTEJNERI I KANTE

38 - 40

WASTE BINS

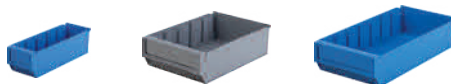

PLASTIČNE RAF KUTIJE

41

PLASTIC SHELF BINS



PLASTIČNE FIJOKA KUTIJE

42 - 47

PLASTIC DRAWER BOXS



PLASTIČNE KUTIJE ZA ODLAGANJE

48 - 51

PLASTIC STACKING BINS



KUTIJE ZA ALAT

52 - 53

PLASTIC TOOL BOXES



PLASTIČNE ORGANAJZER KUTIJE

54 - 55

PLASTIC ORGANIZER BOXES



PLASTIČNE PROZIRNE KUTIJE I KONTEJNERI ZA SKLADIŠTENJE

56

PLASTIC CLEAR BOXES AND STORAGE BOXES



PLASTIČNE KUTIJE SA OTVOROM

57

PLASTIC MANHOLE BOXES



PROIZVODI ZA BEZBEDNOST SAOBRAĆAJA

58 - 64

TRAFFIC SAFETY PRODUCTS

R-KLT i RL-KLT Kutije

KLT kutije proizvedene od PPC-a imaju visoku izdržljivost i koriste se u automobilskoj industriji, pod-industriji, teškoj industriji i mnogim drugim sektorima. Proizvodi se sa dve opcije baze, R-KLT (jaka baza) i RL-KLT (ravna baza).

Zahvaljujući zatvorenim rukohvatima, može se nositi ergonomski i sigurnije. U celoj seriji standardno postoji držač etiketa.

R-KLT & RL-KLT Crates

The KLT crate series are produced from PPC and have high durability. They are used in automotive, sub-industry, heavy industry and many other sectors. R-KLT (reinforced base), RL-KLT (flat base) are produced with two base options. With closed hand grips, crates are more ergonomic and can be carried safely. All serie have standart label pocket.



Ojačana baza
Reinforced Base



Ravna baza
Flat Base



YM-4060

Spo / Ext 420 x 620 x 150 mm
Metalna kolica
Metal dolly



Kod / Code **R-KLT-3215**

Spo / Ext 200 x 300 x 147 mm
Unu / Int 170 x 245 x 125 mm

RL-KLT-3147

200 x 300 x 147 mm
170 x 245 x 143 mm



Kod / Code **R-KLT-4315**

Spo / Ext 300 x 400 x 147 mm
Unu / Int 265 x 340 x 120 mm

RL-KLT-4147

300 x 400 x 147 mm
265 x 340 x 143 mm



Kod / Code **R-KLT-4322**

Spo / Ext 300 x 400 x 215 mm
Unu / Int 265 x 340 x 195 mm

RL-KLT-4213

300 x 400 x 215 mm
265 x 340 x 211 mm



Kod / Code **R-KLT-4329**

Spo / Ext 300 x 400 x 280 mm
Unu / Int 265 x 340 x 255 mm

RL-KLT-4280

300 x 400 x 280 mm
265 x 340 x 276 mm



Kod / Code **R-KLT-6415**

Spo / Ext 400 x 600 x 147 mm
Unu / Int 364 x 544 x 109 mm

RL-KLT-6147

400 x 600 x 147 mm
364 x 544 x 143 mm



Kod / Code **R-KLT-6422**

Spo / Ext 400 x 600 x 215 mm
Unu / Int 364 x 544 x 195 mm

RL-KLT-6213

400 x 600 x 215 mm
364 x 544 x 211 mm



Kod / Code **R-KLT-6429**

Spo / Ext 400 x 600 x 280 mm
Unu / Int 364 x 544 x 255 mm

RL-KLT-6280

400 x 600 x 280 mm
364 x 544 x 276 mm



Kod / Code **R-KLT-6436**

Spo / Ext 400 x 600 x 360 mm
Unu / Int 364 x 544 x 335 mm

RL-KLT-6236

400 x 600 x 360 mm
364 x 544 x 356 mm

400 x 600 mm Zatvorene kutije

Zahvaljujući čvrstoj strukturi, zatvorene kutije omogućavaju siguran transport, skladištenje i slaganje proizvoda. Zatvorene kutije od PPC različitih opcija veličine, boje i osnove kao i otvorenim ili zatvorenim rukohvatima.

400 x 600 mm Solid Crates

The solid crates allow you to carry and store your products safely with their robust structure. PPC solid crates have different size, color, base, open hand grip, closed hand grip options.



Ojačana baza
Reinforced Base



Ravna baza
Flat Base

		Kod / Code Spo / Ext Unu / Int	HP-6503 400 x 600 x 65 mm 365 x 565 x 53 mm	HP-6504 400 x 600 x 65 mm 365 x 565 x 53 mm
		Kod / Code Spo / Ext Unu / Int	HP-1003 400 x 600 x 100 mm 365 x 565 x 88 mm	HP-1004 400 x 600 x 100 mm 365 x 565 x 88 mm
		Kod / Code Spo / Ext Unu / Int	HP-1203 400 x 600 x 120 mm 365 x 565 x 108 mm	HP-1204 400 x 600 x 120 mm 365 x 565 x 108 mm
		Kod / Code Spo / Ext Unu / Int	HP-1503 400 x 600 x 150 mm 365 x 565 x 138 mm	HP-1504 400 x 600 x 150 mm 365 x 565 x 138 mm
		Kod / Code Spo / Ext Unu / Int	HP-1703 400 x 600 x 170 mm 365 x 565 x 158 mm	HP-1704 400 x 600 x 170 mm 365 x 565 x 158 mm
		Kod / Code Spo / Ext Unu / Int	HP-2003 400 x 600 x 200 mm 365 x 565 x 188 mm	HP-2004 400 x 600 x 200 mm 365 x 565 x 188 mm
		Kod / Code Spo / Ext Unu / Int	HP-2303 400 x 600 x 230 mm 365 x 565 x 218 mm	HP-2304 400 x 600 x 230 mm 365 x 565 x 218 mm
		Kod / Code Spo / Ext Unu / Int	HP-2803 400 x 600 x 280 mm 365 x 565 x 268 mm	HP-2804 400 x 600 x 280 mm 365 x 565 x 268 mm

400 x 600 mm Perforirane plastične gajbe

Perforirane plastične gajbe koriste se za voće, povrće, citruse, hranu, poljoprivredu, trgovini, industriji i mnogim drugim sektorima. Perforirani kutije(gajbe) od PPC različitih opcija veličine, boje i osnove kao i otvorenim ili zatvorenim rukohvatima.

400 x 600 mm Perforated Crates

Perforated plastic crates are used in fruits, vegetables, citrus transportation and food, agriculture, market sectors and in many other industries. PPC perforated crates have different size, color, base, open hand grip, closed hand grip options.

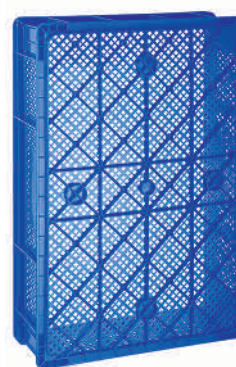

Perforirana baza
Perforated Base

Zatvorena baza
Closed Base

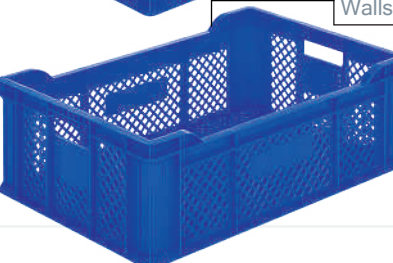
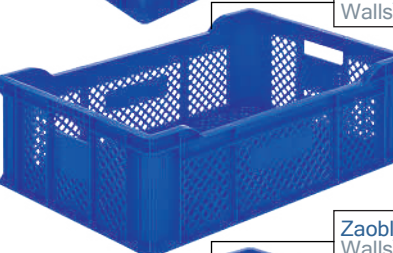
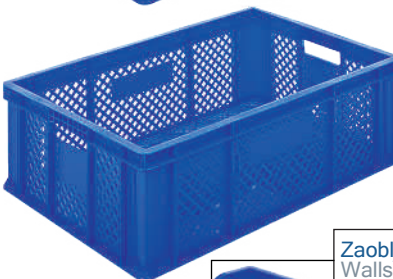
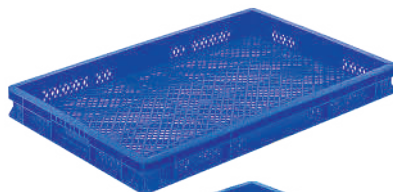
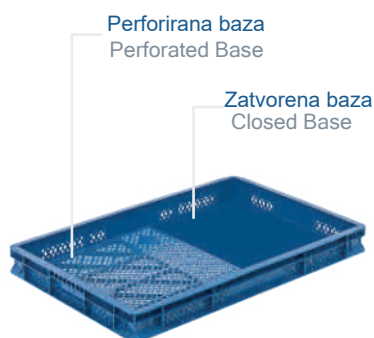

Kod / Code
Spo / Ext
Unu / Int

HP-6501

400 x 600 x 65 mm
365 x 565 x 53 mm

HP-6502

400 x 600 x 65 mm
365 x 565 x 53 mm

Kod / Code
Spo / Ext
Unu / Int

HP-1001

400 x 600 x 100 mm
365 x 565 x 88 mm

HP-1002

400 x 600 x 100 mm
365 x 565 x 88 mm

Kod / Code
Spo / Ext
Unu / Int

HP-1501

400 x 600 x 150 mm
365 x 565 x 137 mm

HP-1502

400 x 600 x 150 mm
365 x 565 x 137 mm

Kod / Code
Spo / Ext
Unu / Int

HP-2001

400 x 600 x 200 mm
365 x 565 x 188 mm

HP-2002

400 x 600 x 200 mm
365 x 565 x 188 mm

Kod / Code
Spo / Ext
Unu / Int

HP-2301

400 x 600 x 230 mm
365 x 565 x 218 mm

HP-2302

400 x 600 x 230 mm
365 x 565 x 218 mm

Zaobljene ivice
Walls with terrace

Kod / Code
Spo / Ext
Unu / Int

HP-2005

400 x 600 x 200 mm
365 x 565 x 188 mm

HP-2006

400 x 600 x 200 mm
365 x 565 x 188 mm

Zaobljene ivice
Walls with terrace

Kod / Code
Spo / Ext
Unu / Int

HP-2305

400 x 600 x 230 mm
365 x 565 x 218 mm

HP-2306

400 x 600 x 230 mm
365 x 565 x 218 mm





Kod / Code **HP-3002**
 Spo / Ext 400 x 600 x 300 mm
 Unu / Int 365 x 565 x 284 mm



Kod / Code **HP-3402**
 Spo / Ext 400 x 600 x 340 mm
 Unu / Int 365 x 565 x 324 mm



Kod / Code **HP-3602**
 Spo / Ext 400 x 600 x 360 mm
 Unu / Int 365 x 565 x 342 mm



Kod / Code **HP-4002**
 Spo / Ext 400 x 600 x 400 mm
 Unu / Int 365 x 565 x 386 mm



Kod / Code **HP-4202**
 Spo / Ext 400 x 600 x 425 mm
 Unu / Int 365 x 565 x 410 mm



Kod / Code **HP-4502**
 Spo / Ext 400 x 600 x 450 mm
 Unu / Int 365 x 565 x 436 mm

400 x 600 mm Kutija

Perforirane plastične gajbe koriste se za voće, povrće, citrusne, hranu, poljoprivredu, trgovini, industriji i mnogim drugim sektorima. Perforirani kutije(gajbe) od PPC različitih opcija veličine, boje i osnove kao i otvorenim ili zatvorenim rukohvatima.

400 x 600 mm Crates

Perforated plastic crates are used in fruits, vegetables, citrus transportation and food, agriculture, market sectors and in many other industries. PPC perforated crates have different size, color, base, open hand grip, closed hand grip options.



HP-40x60
 Spo / Ext 400 x 600 x 20 mm
 Poklopac / Lid



HP-41x61
 Spo / Ext 400 x 600 x 10 mm
 Poklopac / Lid



Kod / Code HP-3003
Spo / Ext 400 x 600 x 300 mm
Unu / Int 365 x 565 x 284 mm

HP-2003-1
Spo / Ext 590 x 390 x 205 mm
560 x 360 x 195 mm



Kod / Code HP-3403
Spo / Ext 400 x 600 x 340 mm
Unu / Int 365 x 565 x 324 mm

400 x 600 mm Kutije

Zahvaljujući čvrstoj strukturi, zatvorene kutije omogućavaju vam siguran transport, skladištenje i slaganje proizvoda. Zatvorene kutije proizvedene od PPC različitih opcija veličine, boje, osnove kao i otvorenim ili zatvorenim rukohvatima.

400 x 600 mm Crates

The solid crates allow you to carry and store your products safely with their robust structure. PPC solid crates have different size, color, base, open hand grip, closed hand grip options.



Kod / Code HP-3603
Spo / Ext 400 x 600 x 360 mm
Unu / Int 365 x 565 x 342 mm

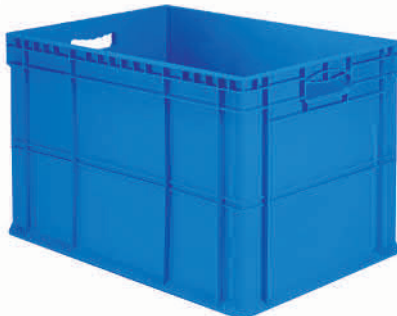

Kod / Code HP-4003
Spo / Ext 400 x 600 x 400 mm
Unu / Int 365 x 565 x 386 mm

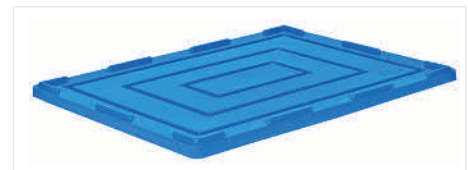

HP-40x60
Spo / Ext 400 x 600 x 20 mm



Kod / Code HP-4203
Spo / Ext 400 x 600 x 425 mm
Unu / Int 365 x 565 x 410 mm

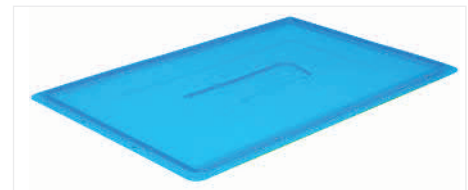

HP-41x61
Spo / Ext 400 x 600 x 10 mm



Kod / Code HP-4503
Spo / Ext 400 x 600 x 450 mm
Unu / Int 365 x 565 x 436 mm

Önü Açık Kasalar Open Front Crates



Kod / Code	HP-4322 AV	HP-4329 AV
Spo / Ext	295 x 395 x 230 mm	295 x 395 x 290 mm
Unu / Int	263 x 265 x 215 mm	263 x 365 x 275 mm



Kod / Code	HP-18 AV	HP-27-AV
Spo / Ext	295 x 505 x 180 mm	295 x 505 x 235 mm
Unu / Int	260 x 470 x 162 mm	260 x 470 x 217 mm



Kod / Code	HP-4622 AV	HP-4628 AV
Spo / Ext	400 x 600 x 220 mm	400 x 600 x 280 mm
Unu / Int	365 x 565 x 205 mm	365 x 565 x 268 mm



Kod / Code	HP-4642 AV	HP-4634 AV
Spo / Ext	400 x 600 x 425 mm	400 x 600 x 340 mm
Unu / Int	365 x 565 x 410 mm	365 x 565 x 325 mm



Kod / Code	HP-4650 AV	HP-4645 AV
Spo / Ext	400 x 600 x 500 mm	400 x 600 x 450 mm
Unu / Int	365 x 565 x 485 mm	365 x 565 x 436 mm



PLASTIČNE KUTIJE ZA TRANSPORT I SKLADISTENJE

PLASTIC CARRYING CRATES

Delikli Kasalar Perforated Crates



Kod / Code **E-24**
Spo / Ext 370 x 520 x 180 mm
Unu / Int 340 x 490 x 160 mm



Kod / Code **A-600-B**
Spo / Ext 365 x 525 x 315 mm
Unu / Int 340 x 500 x 310 mm



Kod / Code **B-550-K**
Spo / Ext 420 x 625 x 260 mm
Unu / Int 380 x 580 x 240 mm



Kod / Code **E-35**
Spo / Ext 375 x 520 x 195 mm
Unu / Int 340 x 490 x 180 mm



Kod / Code **E-100**
Spo / Ext 300 x 400 x 120 mm
Unu / Int 285 x 360 x 110 mm



Kod / Code **AX-850**
Spo / Ext 444 x 634 x 150 mm
Unu / Int 435 x 620 x 134 mm



Kod / Code **E-5421**
Spo / Ext 400 x 500 x 210 mm
Unu / Int 370 x 470 x 200 mm



Kod / Code **E-6430**
Spo / Ext 400 x 600 x 310 mm
Unu / Int 370 x 570 x 300 mm



Kod / Code **E-6440**
Spo / Ext 400 x 600 x 410 mm
Unu / Int 370 x 570 x 400 mm



Kod / Code **GK-910**
Spo / Ext 425 x 655 x 390 mm
Unu / Int 395 x 635 x 380 mm



400 X 600 mm Industrijske kutije 400 X 600 mm Industrial Crates



Kod / Code **HP-4615**
Spo / Ext 400 x 600 x 145 mm
Unu / Int 360 x 560 x 130 mm



Kod / Code **HP-4617**
Spo / Ext 400 x 600 x 170 mm
Unu / Int 360 x 560 x 155 mm



Kod / Code **HP-4622**
Spo / Ext 400 x 600 x 220 mm
Unu / Int 360 x 560 x 205 mm



Kod / Code **HP-4628**
Spo / Ext 400 x 600 x 280 mm
Unu / Int 360 x 560 x 265 mm



Kod / Code **HP-4632**
Spo / Ext 400 x 600 x 325 mm
Unu / Int 360 x 560 x 310 mm



Kod / Code **HP-4642**
Spo / Ext 400 x 600 x 425 mm
Unu / Int 360 x 560 x 410 mm



Kod / Code **HP-4650**
Spo / Ext 400 x 600 x 500 mm
Unu / Int 360 x 560 x 485 mm



Ojačana baza
Reinforced base



Rukohvat sa zaštitom za ruku
Hand protected grip



Nosač oznake
Kanban Label Slot

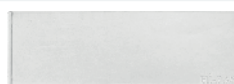

HP-100 / Oznaka
HP-100 / Kanban Label



HP-40x60
Spo / Ext 400 x 600 x 20 mm
Poklopac / Lid



Točkici-opcija
Optional wheels



Akcesoari-dodaci Accessories



HP-41x61

Spo / Ext 400 x 600 x 10 mm
400 X 600 mm Poklopac / Lid



AX-40x60

Spo / Ext 400 x 600 x 20 mm
400 X 600 mm Poklopac / Lid



HP-34x54

Spo / Ext 340 x 540 x 10 mm
Yatay Separatör
Flat Separators



T-50 50x75 mm
Točkići / Wheel

HP-4615, HP-4617
HP-4622, HP-4628



T-75 75x105 mm
Točkići / Wheel

HP-4632, HP-4642
HP-4650, HP-6943-K



Dolly 4060

Kod / Code
Spo / Ext 420 x 600 x 190 mm
Plastična kolica / Plastic dolly



YM-4060

Kod / Code
Spo / Ext 420 x 620 x 150 mm
Metalna kolica / Metal dolly



Dolly 4161

Kod / Code
Spo / Ext 420 x 600 x 190 mm
Plastična kolica / Plastic dolly

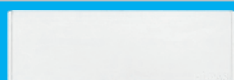

HP-100

Prozirni držač etiketa
Transparent label holder

Primenljive kutije: Applicable Crates :

HP-4615, HP-4617, HP-4622, HP-4628,
HP-4632, HP-4642, HP-4650



Prozirni držač etiketa Sticker kanban label holders



DIMENZIJA 225x160
225 X 160 mm



DIMENZIJA 225x90
225 X 90 mm



DIMENZIJA 150x90
150 X 90 mm



DIMENZIJA 110x110
110 X 110 mm

Uspravni separatori Upright separators

SPR-26 260X90 mm



SPR-39 356X90 mm



SPR-59 556X90 mm



SPR-2618 260X185 mm



SPR-3618 356X185 mm



SPR-5618 556X185 mm



SPR-3615 352X150 mm



SPR-5615 555X150 mm



400 X 600 mm KUTIJE SA POKLOPCEM I ŠARKAMA 400 X 600 mm Industrial Crates With Hinged Lids



Kod / Code **HP-4615 MK**
Spo / Ext 400 x 600 x 165 mm
Unu / Int 360 x 560 x 130 mm



Kod / Code **HP-4617 MK**
Spo / Ext 400 x 600 x 190 mm
Unu / Int 360 x 560 x 155 mm



Kod / Code **HP-4622 MK**
Spo / Ext 400 x 600 x 240 mm
Unu / Int 360 x 560 x 205 mm



Kod / Code **HP-4628 MK**
Spo / Ext 400 x 600 x 300 mm
Unu / Int 360 x 560 x 265 mm



Kod / Code **HP-4632 MK**
Spo / Ext 400 x 600 x 345 mm
Unu / Int 360 x 560 x 310 mm



Kod / Code **HP-4642 MK**
Spo / Ext 400 x 600 x 445 mm
Unu / Int 360 x 560 x 410 mm



Kod / Code **HP-4650 MK**
Spo / Ext 400 x 600 x 520 mm
Unu / Int 360 x 560 x 485 mm



Ojačana baza
Reinforced base



Rukohvat sa zaštitom za ruku
Hand protected grip



Nosač oznake
Kanban Label Slot

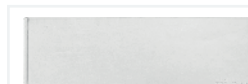

HP-100 / Oznaka
HP-100 / Kanban Label



Točkići- opcija
Optional wheels



PLASTIČNE KUTIJE ZA TRANSPORT I SKLADISTENJE

PLASTIC CARRYING CRATES

480x690 mm Kutije/Gajbe 480x690 mm Crates



Kod / Code **HP-6943-A**
Spo / Ext 480 x 690 x 430 mm
Unu / Int 440 x 650 x 420 mm



Kod / Code **HP-6943-K**
Spo / Ext 480 x 690 x 430 mm
Unu / Int 440 x 650 x 420 mm



Kod / Code **HP-6943-AT**
Spo / Ext 480 x 690 x 540 mm
Unu / Int 440 x 650 x 420 mm



Kod / Code **HP-6943-KT**
Spo / Ext 480 x 690 x 540 mm
Unu / Int 440 x 650 x 420 mm



Kod / Code **HP-6943-MK**
Spo / Ext 480 x 690 x 455 mm
Unu / Int 440 x 650 x 420 mm



Kod / Code **HP-6943-MKT**
Spo / Ext 480 x 690 x 555 mm
Unu / Int 440 x 650 x 420 mm



Kod / Code **HP-6943-AV**
Spo / Ext 480 x 690 x 430 mm
Unu / Int 440 x 650 x 420 mm

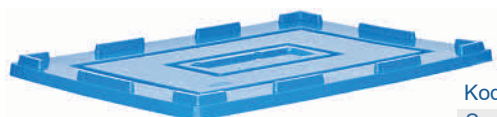

Kod / Code **HP-43X69**
Spo / Ext 480 x 690 x 25 mm
480 x 690 mm Poklopac / Lid



Industrijske kutije Industrial Crates



Ojačana baza
Reinforced Base



Ravna baza
Flat Base



Kod / Code

Spo / Ext

Unu / Int

H-2111

148 x 200 x 120 mm

114 x 164 x 114 mm



Kod / Code

Spo / Ext

Unu / Int

H-3211 F

200 x 300 x 120 mm

162 x 262 x 103 mm

H-3211 D

200 x 300 x 120 mm

162 x 262 x 115 mm



Kod / Code

Spo / Ext

Unu / Int

H-3220 F

200 x 300 x 200 mm

162 x 262 x 185 mm



Kod / Code

Spo / Ext

Unu / Int

H-3220 AV

195 x 295 x 200 mm

160 x 255 x 185 mm



H-3220 BL

Kod / Code

Spo / Ext 158 x 75 x 3 mm

Providni prozor
transparent window

HP-20x30 Kapak / Lid

200 x 300 x 10 mm

Poklopac / Lid

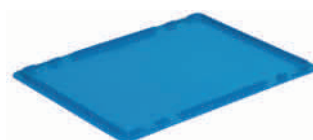

Kod / Code

Spo / Ext

Unu / Int

KN-1322

296 x 996 x 213 mm

262 x 962 x 211 mm

300x400 mm Kutije 300x400 mm Crates



Ojačana baza
Reinforced Base

Ravna baza
Flat Base



Kod / Code

Spo / Ext

Unu / Int

HP-4311 D

295 x 395 x 117 mm

263 x 365 x 112 mm



Kod / Code

Spo / Ext

Unu / Int

HP-4316 F

295 x 395 x 174 mm

263 x 365 x 160 mm

HP-4316 D

295 x 395 x 174 mm

263 x 365 x 170 mm



Kod / Code

Spo / Ext

Unu / Int

HP-4322 F

295 x 395 x 230 mm

263 x 365 x 215 mm

HP-4322 D

295 x 395 x 230 mm

263 x 365 x 225 mm



Kod / Code

Spo / Ext

Unu / Int

HP-4322 AV

295 x 395 x 230 mm

263 x 365 x 215 mm



Kod / Code

Spo / Ext

Unu / Int

HP-4329 F

295 x 395 x 290 mm

263 x 365 x 275 mm

HP-4329 D

295 x 395 x 290 mm

263 x 365 x 285 mm



Kod / Code

Spo / Ext

Unu / Int

HP-4329 AV

295 x 395 x 290 mm

263 x 365 x 275 mm

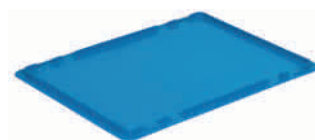

HP-30x40 Poklopac / Lid

Spo / Ext 300 x 400 x 10 mm

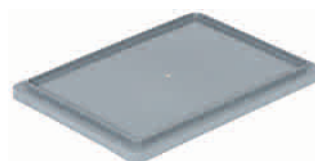

HP-31x41 Poklopac / Lid

Spo / Ext 303 x 405 x 30 mm

Industrijske kutije Industrial Crates



Kod / Code **HP-160 K**
Spo / Ext 256 x 505 x 165 mm
Unu / Int 224 x 470 x 150 mm



Kod / Code **HP-260 K**
Spo / Ext 256 x 505 x 221 mm
Unu / Int 224 x 470 x 207 mm



HP-26x50 256 x 505 x 10 mm
 HP-160-K i HP-260-K Poklopac
 HP-160-K and HP-260-K Lid



Kod / Code **HP-18 K**
Spo / Ext 295 x 505 x 180 mm
Unu / Int 260 x 470 x 207 mm

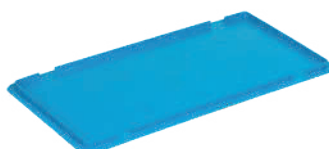

HP-30x50 295 x 505 x 10 mm
 HP-18-K i HP-27-K Poklopac
 Lid for HP-18-K and HP-27-K



Kod / Code **HP-18-AV**
Spo / Ext 295 x 505 x 180 mm
Unu / Int 260 x 470 x 162 mm



Kod / Code **HP-27-K**
Spo / Ext 295 x 505 x 235 mm
Unu / Int 260 x 470 x 217 mm



Kod / Code **HP-27-AV**
Spo / Ext 295 x 505 x 235 mm
Unu / Int 260 x 470 x 217 mm



Kod / Code **HP-270-K**
Spo / Ext 355 x 415 x 190 mm
Unu / Int 330 x 385 x 175 mm



Sklopive plastične kutije Folding Solid Crates

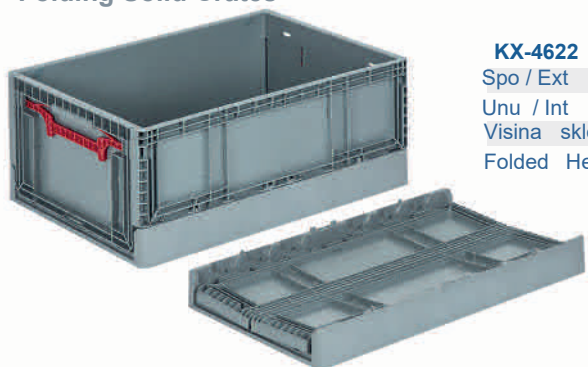

KX-4622

Spo / Ext	400 x 600 x 230 mm
Unu / Int	365 x 560 x 220 mm
Visina sklopljene	73 mm
Folded Height	73 mm

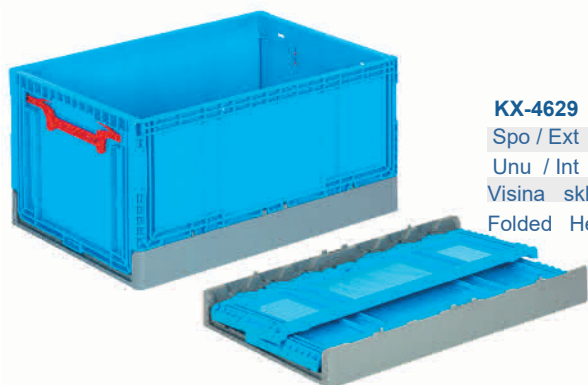

KX-4629

Spo / Ext	400 x 600 x 290 mm
Unu / Int	365 x 560 x 280 mm
Visina sklopljene	73 mm
Folded Height	73 mm



Sklopive sa ručicama
Folding with hand latch



KT-4322

Spo / Ext	296 x 395 x 230 mm
Unu / Int	255 x 355 x 226 mm
Visina sklopljene	65 mm
Folded Height	65 mm



KT-4633

Spo / Ext	395 x 604 x 340 mm
Unu / Int	364 x 562 x 326 mm
Visina sklopljene	80 mm
Folded Height	80 mm



KT-4822-F

Spo / Ext	400 x 800 x 230 mm
Unu / Int	362 x 759 x 213 mm
Visina sklopljene	53 mm
Folded Height	53 mm



KT-8634

Spo / Ext	600 x 800 x 340 mm
Unu / Int	565 x 764 x 334 mm
Visina sklopljene	80 mm
Folded Height	80 mm



Sklopive perforirane kutije Folding Perforated Crates



PG-6411

Spo / Ext 400 x 600 x 115 mm
Unu / Int 376 x 576 x 106 mm
Visina sklopljene 30 mm
Folded Height 30 mm



PG-6415

Spo / Ext 400 x 600 x 150 mm
Unu / Int 376 x 576 x 141 mm
Visina sklopljene 30 mm
Folded Height 30 mm



PG-6418

Spo / Ext 400 x 600 x 185 mm
Unu / Int 362 x 576 x 176 mm
Visina sklopljene 30 mm
Folded Height 30 mm



PG-6422

Spo / Ext 400 x 600 x 219 mm
Unu / Int 362 x 576 x 210 mm
Visina sklopljene 30 mm
Folded Height 30 mm

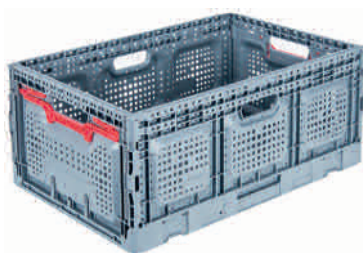

PG-6426

Spo / Ext 400 x 600 x 259 mm
Unu / Int 376 x 576 x 251 mm
Visina sklopljene 47 mm
Folded Height 47 mm



KTA-6422

Spo / Ext 400 x 600 x 225 mm
Unu / Int 372 x 572 x 215 mm
Visina sklopljene 40 mm
Folded Height 40 mm

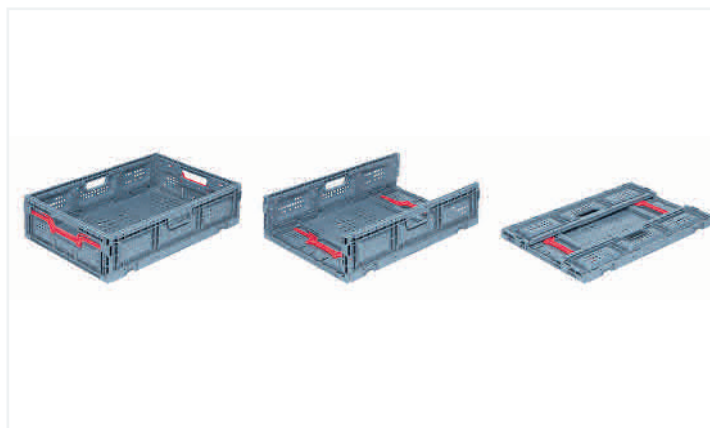

KTA-4316

Spo / Ext 400 x 300 x 158 mm
Unu / Int 372 x 573 x 150 mm
Visina sklopljene 28 mm
Folded Height 28 mm



KT-6416

Spo / Ext 400 x 600 x 157 mm
Unu / Int 372 x 573 x 153 mm
Visina sklopljene 32 mm
Folded Height 32 mm



KT-6418

Spo / Ext 400 x 600 x 177 mm
Unu / Int 372 x 573 x 173 mm
Visina sklopljene 32 mm
Folded Height 32 mm



KT-6420

Spo / Ext 400 x 600 x 197 mm
Unu / Int 372 x 573 x 193 mm
Visina sklopljene 32 mm
Folded Height 32 mm



PLASTIČNE KUTIJE ZA TRANSPORT I SKLADISTENJE

PLASTIC CARRYING CRATES

Konusne plastične kutije sa poklopcem

- Slaganje i transportovanje jedana na drugu zatvorenih poklopaca.
- Kada su poklopci otvoreni, omogućavaju uštedu prostora slaganjem jedne u drugu.
- Pogodno za upotrebu u transportnom sistemu.
- Proizvedene je prema Eurobok standardima.
- proizvode se u 4 različite visine
- Sa svojom plastičnom stezaljkom i upotrebom zaptivača, vaši proizvodi će biti transportovani sa sigurnošću,

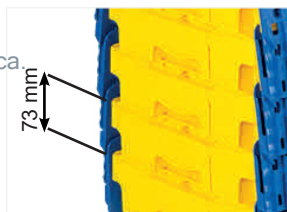

Visina slaganja
Nesting height



ALC Attached Lid Crates

- Can be stacked and transported on top of each other when the lids are closed.
- When the lids are open, the nested design allows to save from the volume.
- Suitable for conveyor systems.
- Can be stacked with 4 different heights.
- Plastic cable tie and seal can be applied that your products are transported safely

300 x 400 Konusne plastične kutije

300 x 400 ALC Attached Lid Crates



HP-4321-MK

Spo / Ext 300 x 400 x 210 mm
Unu / Int 265 x 340 x 190 mm



HP-4325-MK

Spo / Ext 300 x 400 x 250 mm
Unu / Int 265 x 340 x 230 mm



HP-4332-MK

Spo / Ext 300 x 400 x 320 mm
Unu / Int 265 x 340 x 300 mm



HP-4336-MK

Spo / Ext 300 x 400 x 365 mm
Unu / Int 265 x 340 x 345 mm

400 x 600 Konusne plastične kutije

400 x 600 ALC Attached Lid Crates

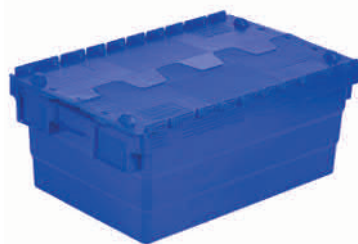

HP-6425-MK

Spo / Ext 400 x 600 x 250 mm
Unu / Int 365 x 543 x 232 mm

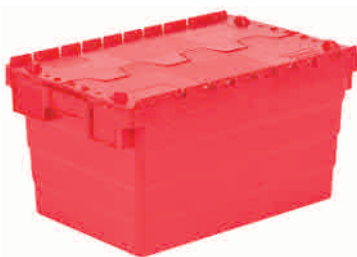

HP-6432-MK

Spo / Ext 400 x 600 x 320 mm
Unu / Int 365 x 545 x 302 mm



HP-6435-MK

Spo / Ext 400 x 600 x 360 mm
Unu / Int 365 x 545 x 347 mm



HP-6440-MK

Spo / Ext 400 x 600 x 415 mm
Unu / Int 365 x 545 x 398 mm



Mogućnost pregrađivanja separatorima
PP sheet separators can be applied on all our designs .



Osiguravanje uz pomoć vezica
Plastic cable tie can be applied

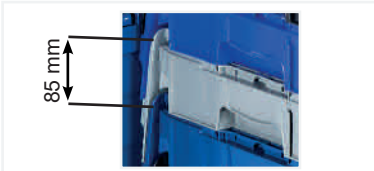

Visina slaganja
Nesting height



Konusne plastične kutije sa poklopcem

Nestable Crates



HX-2311-MK

Spo / Ext 225 x 295 x 125 mm
Unu / Int 200 x 270 x 108 mm



HX-2316-MK

Spo / Ext 225 x 295 x 175 mm
Unu / Int 200 x 270 x 158 mm



HX-5316-MK

Spo / Ext 300 x 490 x 175 mm
Unu / Int 257 x 430 x 155 mm



HX-5322-MK

Spo / Ext 300 x 490 x 235 mm
Unu / Int 257 x 430 x 210 mm



HX-5326-MK

Spo / Ext 300 x 490 x 275 mm
Unu / Int 257 x 430 x 255 mm



HX-5311

Spo / Ext 300 x 490 x 110 mm
Unu / Int 257 x 430 x 107 mm



HX-5316

Spo / Ext 300 x 490 x 160 mm
Unu / Int 257 x 430 x 155 mm



HX-5322

Spo / Ext 300 x 490 x 220 mm
Unu / Int 257 x 430 x 210 mm



HX-5326

Spo / Ext 300 x 490 x 260 mm
Unu / Int 257 x 430 x 255 mm

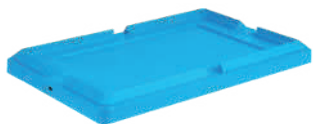

HX-5300

Spo / Ext 310 x 503 x 50 mm

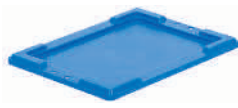

HX-2300

Spo / Ext 230 x 302 x 15 mm



HX-2311

Spo / Ext 225 x 295 x 110 mm
Unu / Int 200 x 270 x 108 mm



HX-2316

Spo / Ext 225 x 295 x 160 mm
Unu / Int 200 x 270 x 158 mm



400 x 800 Kutije 400 x 800 Crates

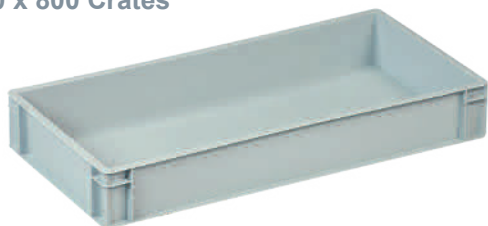

Kod / Code H-4811
Spo / Ext 400 x 800 x 119 mm
Unu / Int 356 x 758 x 109 mm

400 x 1200 Kutije 400 x 1200 Crates



Kod / Code H-4111
Spo / Ext 400 x 1200 x 119 mm
Unu / Int 358 x 1157 x 108 mm



Kod / Code H-4816
Spo / Ext 400 x 800 x 171 mm
Unu / Int 352 x 752 x 158 mm

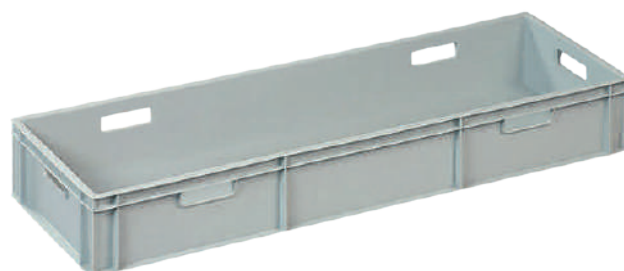

Kod / Code H-4116
Spo / Ext 400 x 1200 x 171 mm
Unu / Int 354 x 1154 x 158 mm



Kod / Code H-4822
Spo / Ext 400 x 800 x 227 mm
Unu / Int 352 x 752 x 215 mm



Kod / Code H-4122
Spo / Ext 400 x 1200 x 230 mm
Unu / Int 354 x 1154 x 215 mm



Kod / Code H-4828
Spo / Ext 400 x 800 x 278 mm
Unu / Int 348 x 748 x 265 mm



Kod / Code H-4133
Spo / Ext 400 x 1200 x 338 mm
Unu / Int 350 x 1154 x 324 mm



Kod / Code YM-4080
Spo / Ext 420 x 820 x 150 mm
 Metalna kolica / Metal dolly



Kod / Code YM-4120
Spo / Ext 420 x 1220 x 150 mm
 Metalna kolica / Metal dolly

600x800 mm Kutije 600x800 mm Crates



Kod / Code **H-8611**
Spo / Ext 600 x 800 x 119 mm
Unu / Int 559 x 753 x 107 mm



Kod / Code **H-8616**
Spo / Ext 600 x 800 x 174 mm
Unu / Int 555 x 750 x 162 mm



Kod / Code **H-8622**
Spo / Ext 600 x 800 x 230 mm
Unu / Int 555 x 750 x 215 mm



Kod / Code **H-8633**
Spo / Ext 600 x 800 x 340 mm
Unu / Int 555 x 750 x 325 mm



Kod / Code **H-8638**
Spo / Ext 600 x 800 x 388 mm
Unu / Int 555 x 748 x 374 mm



Kod / Code **H-8644**
Spo / Ext 600 x 800 x 450 mm
Unu / Int 552 x 747 x 435 mm



Kod / Code **HP-61X81**
Spo / Ext 600 x 800 x 20 mm
Poklopac kutije 600X800 mm
Lid for 600X800 mm Crates



Kod / Code **H-8622-MK**
Spo / Ext 600 x 800 x 250 mm
Unu / Int 555 x 750 x 215 mm



Kod / Code **H-8633-MK**
Spo / Ext 600 x 800 x 360 mm
Unu / Int 555 x 750 x 325 mm



YM-60X80
Spo / Ext 620 x 820 x 160 mm
600 X 800 mm Metalna kolica / Metaldolly



Kod / Code **H-8644-MK**
Spo / Ext 600 x 800 x 450 mm
Unu / Int 555 x 750 x 435 mm

Box palette
Plastic Containers



Kod / Code GK-2100-K
Spo / Ext 610 x 810 x 510 mm
Unu / Int 565 x 770 x 445 mm



Kod / Code GK-2100-KT
Spo / Ext 610 x 810 x 640 mm
Unu / Int 565 x 770 x 445 mm



HP-61X81
Spo / Ext 620 x 820 x 20 mm
Poklopac kutije 610X800 mm
Lid for 610X810 mm Crates



Kod / Code K-330
Spo / Ext 670 x 930 x 625 mm
Unu / Int 620 x 890 x 520 mm



Kod / Code K-330-T
Spo / Ext 670 x 930 x 770 mm
Unu / Int 620 x 890 x 520 mm



Kod / Code K-310
Spo / Ext 560 x 760 x 513 mm
Unu / Int 520 x 723 x 450 mm



Kod / Code K-310-T
Spo / Ext 560 x 760 x 663 mm
Unu / Int 520 x 723 x 450 mm

Box palete-zatvorene

Closed Containers



K-370		Zapremina	Dinamički	Statički
Spo / Ext	640 x 1000 x 550 mm	Volume	kapacitet	kapacitet
Unu / Int	585 x 932 x 395 mm	200 Lt	300 Kg	1800 Kg
Zatvorena / Closed	Težina / Weight	10,50 kg		



K-370 T		Zapremina	Dinamički	Statički
Spo / Ext	640 x 1000 x 667 mm	Volume	kapacitet	kapacitet
Unu / Int	585 x 932 x 395 mm	200 Lt	300 Kg	1800 Kg
Zatvorena / Closed	Težina / Weight	12,50 kg		



K-400		Zapremina	Dinamički	Statički
Spo / Ext	636 x 1017 x 673 mm	Volume	kapacitet	kapacitet
Unu / Int	585 x 932 x 512 mm	270 Lt	300 Kg	1800 Kg
Zatvorena / Closed	Težina / Weight	12,00 kg		



K-400 T		Zapremina	Dinamički	Statički
Spo / Ext	636 x 1017 x 790 mm	Volume	kapacitet	kapacitet
Unu / Int	585 x 932 x 512 mm	270 Lt	300 Kg	1800 Kg
Zatvorena / Closed	Težina / Weight	14,50 kg		

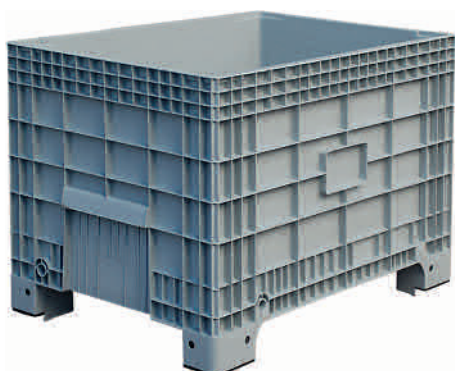

K-550		Zapremina	Dinamički	Statički
Spo / Ext	800 x 1200 x 800 mm	Volume	kapacitet	kapacitet
Unu / Int	732 x 1106 x 617 mm	500 Lt	400 Kg	2500 Kg
Zatvorena / Closed	Težina / Weight	22,00 kg		



K-550 T		Zapremina	Dinamički	Statički
Spo / Ext	800 x 1200 x 925 mm	Volume	kapacitet	kapacitet
Unu / Int	732 x 1108 x 617 mm	500 Lt	400 Kg	2500 Kg
Zatvorena / Closed	Težina / Weight	25,50 kg		



HP-65x100

Spo / Ext 650 x 1050 x 54 mm
Poklopac za K-370 i K-400
Lid for K-370 and K-400



HP-82x120

Spo / Ext 805 x 1270 x 60 mm
Poklopac za K-550
Lid for K-550

Perforirane box palette
Perforated Containers

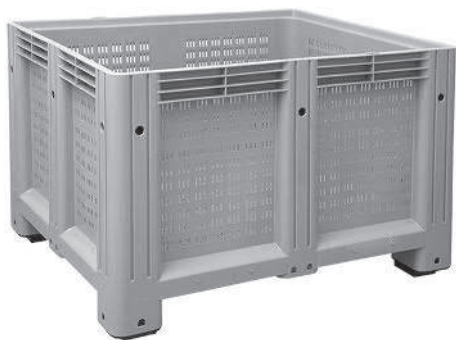

K-6500-A		Zapremina	Dinamički	Statički
Spo / Ext	1000 x 1200 x 580 mm	Volume	kapacitet	kapacitet
Unu / Int	920 x 1120 x 430 mm	450 Lt	700 Kg	4000 Kg
Perforirana / Perforated	Težina / Weight	28,00 kg		

K-6500-AT		Zapremina	Dinamički	Statički
Spo / Ext	1000 x 1200 x 730 mm	Volume	kapacitet	kapacitet
Unu / Int	920 x 1120 x 430 mm	450 Lt	700 Kg	4000 Kg
Perforirana / Perforated	Težina / Weight	33,00 kg		

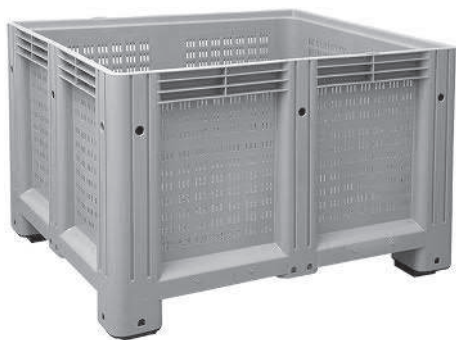

K-6600-A		Zapremina	Dinamički	Statički
Spo / Ext	1000 x 1200 x 760 mm	Volume	kapacitet	kapacitet
Unu / Int	920 x 1120 x 610 mm	625 Lt	700 Kg	4000 Kg
Perforirana / Perforated	Težina / Weight	34,00 kg		

K-6600-AT		Zapremina	Dinamički	Statički
Spo / Ext	1000 x 1200 x 910 mm	Volume	kapacitet	kapacitet
Unu / Int	920 x 1120 x 610 mm	625 Lt	700 Kg	4000 Kg
Perforirana / Perforated	Težina / Weight	39,00 kg		

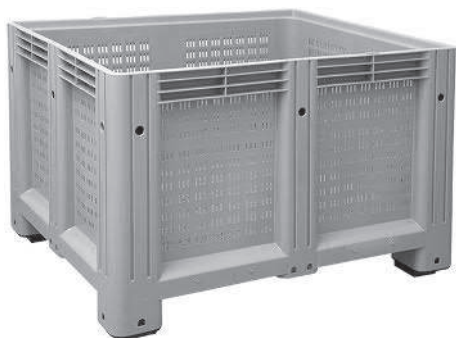

K-6700-A		Zapremina	Dinamički	Statički
Spo / Ext	1000 x 1200 x 850 mm	Volume	kapacitet	kapacitet
Unu / Int	920 x 1120 x 700 mm	720 Lt	700 Kg	4000 Kg
Perforirana / Perforated	Težina / Weight	36,00 kg		

K-6700-AT		Zapremina	Dinamički	Statički
Spo / Ext	1000 x 1200 x 1000 mm	Volume	kapacitet	kapacitet
Unu / Int	920 x 1120 x 700 mm	720 Lt	700 Kg	4000 Kg
Perforirana / Perforated	Težina / Weight	41,00 kg		

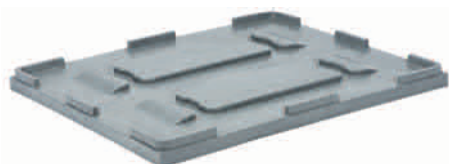

HP-102X120	
Spo / Ext	1020 x 1200 x 60 mm
Poklopac za K-6500, K-6600 i K-6700 Lid for K-6500, K-6600 and K-6700	

Zatvorene box palete
Closed Containers



K-6500-K		Zapremina	Dinamički	Statički
Spo / Ext	1000 x 1200 x 580 mm	Volume	kapacitet	kapacitet
Unu / Int	920 x 1120 x 430 mm	450 Lt	700 Kg	4000 Kg
Zatvorena / Closed	Težina / Weight	29,50 kg		



K-6500-KT		Zapremina	Dinamički	Statički
Spo / Ext	1000 x 1200 x 730 mm	Volume	kapacitet	kapacitet
Unu / Int	920 x 1120 x 430 mm	450 Lt	700 Kg	4000 Kg
Zatvorena / Closed	Težina / Weight	34,00 kg		



K-6600-K		Zapremina	Dinamički	Statički
Spo / Ext	1000 x 1200 x 760 mm	Volume	kapacitet	kapacitet
Unu / Int	920 x 1120 x 610 mm	450 Lt	700 Kg	4000 Kg
Zatvorena / Closed	Težina / Weight	36,00 kg		



K-6600-KT		Zapremina	Dinamički	Statički
Spo / Ext	1000 x 1200 x 910 mm	Volume	kapacitet	kapacitet
Unu / Int	920 x 1120 x 610 mm	625 Lt	700 Kg	4000 Kg
Zatvorena / Closed	Težina / Weight	41,00 kg		



K-6700-K		Zapremina	Dinamički	Statički
Spo / Ext	1000 x 1200 x 850 mm	Volume	kapacitet	kapacitet
Unu / Int	920 x 1120 x 700 mm	720 Lt	700 Kg	4000 Kg
Zatvorena / Closed	Težina / Weight	38,00 kg		



K-6700-KT		Zapremina	Dinamički	Statički
Spo / Ext	1000 x 1200 x 1000 mm	Volume	kapacitet	kapacitet
Unu / Int	920 x 1120 x 700 mm	720 Lt	700 Kg	4000 Kg
Zatvorena / Closed	Težina / Weight	43,00 kg		

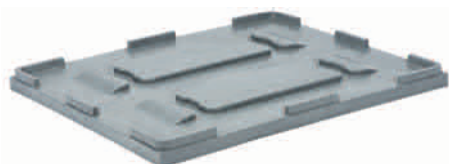

HP-102X120	
Spo / Ext	1020 x 1200 x 60 mm
Poklopac za K-6500, K-6600 i K-6700 Lid for K-6500, K-6600 and K-6700	

Sklopive box palete
Folding Containers



KT-1210-A	W	L	H	Zapremina	Dinamički	Statički
Spo / Ext	1000 x 1200 x 800 mm	Volume	kapacitet	kapacitet		
Unu / Int	920 x 1120 x 650 mm	670 Lt	500 Kg	5000 Kg		
Visina sklopljene / Folded Height	290 mm					
Perforirana/ Perforated	Težina / Weight		41 kg+/- %3			



KT-1210-K	W	L	H	Zapremina	Dinamički	Statički
Spo / Ext	1000 x 1200 x 800 mm	Volume	kapacitet	kapacitet		
Unu / Int	920 x 1120 x 650 mm	670 Lt	500 Kg	5000 Kg		
Visina sklopljene / Folded Height	290 mm					
Zatvorena / Closed	Težina / Weight		42 kg+/- %3			

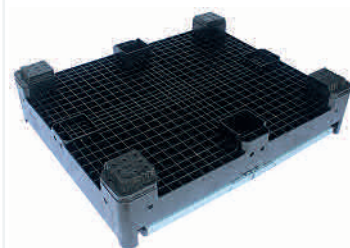

Standard 4 stope
Standard 4 Feet



KT-1212-A	W	L	H	Zapremina	Dinamički	Statički
Spo / Ext	1200 x 1200 x 800 mm	Volume	kapacitet	kapacitet		
Unu / Int	1120 x 1120 x 650 mm	820 Lt	500 Kg	5000 Kg		
Visina sklopljene / Folded Height	290 mm					
Perforirana/ Perforated	Težina / Weight		44 kg+/- %3			



2 Skije-Opcija
Optional 2 Runners



KT-1212-K	W	L	H	Zapremina	Dinamički	Statički
Spo / Ext	1200 x 1200 x 800 mm	Volume	kapacitet	kapacitet		
Unu / Int	1120 x 1120 x 650 mm	820 Lt	500 Kg	5000 Kg		
Visina sklopljene / Folded Height	290 mm					
Zatvorena / Closed	Težina / Weight		45 kg+/- %3			



Otvaranje-Opcija
Optional Flap

Sklopive box palette
Folding Containers

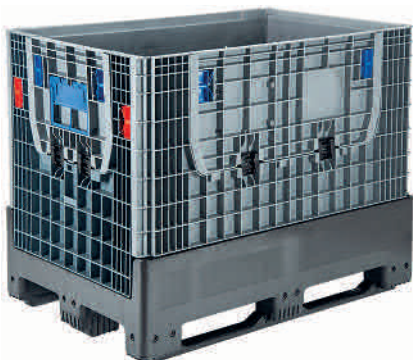

KT-1208-80

Spo / Ext 800 x 1200 x 800 mm
Unu / Int 720 x 1120 x 630 mm
Visina sklopljene. Folded Height 344 mm



KT-1210-80

Spo / Ext 1000 x 1200 x 805 mm
Unu / Int 920 x 1120 x 635 mm
Visina sklopljene Folded Height 349 mm



KT-1208-95

Spo / Ext 800 x 1200 x 950 mm
Unu / Int 720 x 1120 x 780 mm
Visina sklopljene Folded Height 344 mm

KT-1210-95

Spo / Ext 1000 x 1200 x 975 mm
Unu / Int 920 x 1120 x 805 mm
Visina sklopljene Folded Height 349 mm

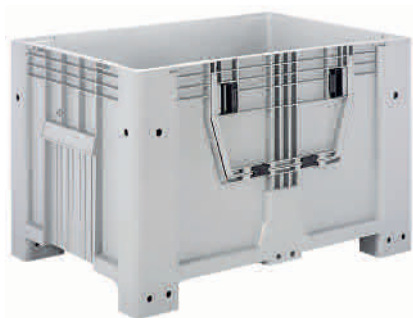

K-570

		Zapremina	Dinamički	Statički
		Volume	kapacitet	kapacitet
Spo / Ext	800 x 1200 x 800 mm	500 Lt	400 Kg	2500 Kg
Unu / Int	737 x 1013 x 632 mm			



K-570-T

		Zapremina	Dinamički	Statički
		Volume	kapacitet	kapacitet
Spo / Ext	800 x 1200 x 925 mm	500 Lt	400 Kg	2500 Kg
Unu / Int	737 x 1013 x 632 mm			



AX-8633

Spo / Ext 800 x 600 x 325 mm
Unu / Int 695 x 490 x 295 mm

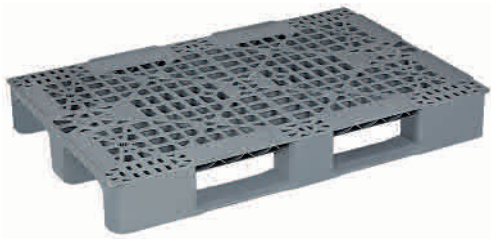

80-120 Perforirana / Perforated	Statički kapacitet	Dinamički kapacitet	Raf kapacitet
800 x 1200 x 150 mm	3000 Kg	1000 Kg	600 Kg



80-120 Zatvorena / Closed	Statički kapacitet	Dinamički kapacitet	Raf kapacitet
800 x 1200 x 150 mm	3000 Kg	1000 Kg	600 Kg



100-120 Perforirana / Perforated	Statički kapacitet	Dinamički kapacitet	Raf kapacitet
1000 x 1200 x 150 mm	3000 Kg	1000 Kg	600 Kg



100-120 Zatvorena / Closed	Statički kapacitet	Dinamički kapacitet	Raf kapacitet
1000 x 1200 x 150 mm	3000 Kg	1000 Kg	600 Kg

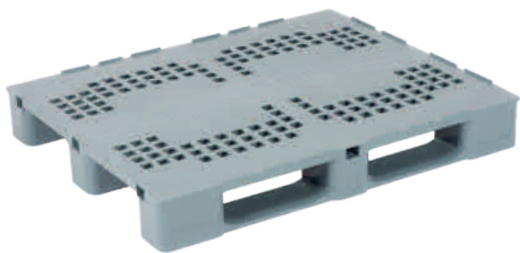

80-120 MW-P Mogućnost profila / Profile Slot	Statički kapacitet	Dinamički kapacitet	Raf kapacitet
800 x 1200 x 150 mm	5000 Kg	1500 Kg	900 Kg
	Težina / Weight		14.00 Kg



80-120 MP-P Mogućnost profila / Profile Slot	Statički kapacitet	Dinamički kapacitet	Raf kapacitet
800 x 1200 x 150 mm	5000 Kg	1500 Kg	900 Kg
	Težina / Weight		15.00 Kg



60-80 Zatvorena / Closed	Statički kapacitet	Raf kapacitet
600 x 800 x 150 mm	2000 Kg	500 Kg

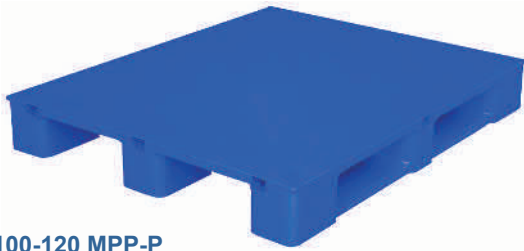

100-120 MPP-P

Mogućnost profila / Profile Slot			Statički kapacitet	Dinamički kapacitet	Raf kapacitet
W	L	H			
1000	1200	155	5000 Kg	1500 Kg	1000 Kg
			Težina / Weight		18.00 Kg



100-120 MW-P

Mogućnost profila / Profile slot			Statički kapacitet	Dinamički kapacitet	Raf kapacitet
W	L	H			
1000	1200	155	5000 Kg	1500 Kg	1000 Kg
			Težina / Weight		17.00 Kg



100-120 MPP-5

Mogućnost profila / Profile Slot			Statički kapacitet	Dinamički kapacitet	Raf kapacitet
W	L	H			
1000	1200	155	5000 Kg	1500 Kg	1000 Kg
			Težina / Weight		18,50 Kg



100-120 MWP-5

Mogućnost profila / Profile Slot			Statički kapacitet	Dinamički kapacitet	Raf kapacitet
W	L	H			
1000	1200	155	5000 Kg	1500 Kg	1000 Kg
			Težina / Weight		18,50 Kg



Kapacitet sa 1 metalnim profilom
1 Metal Profile Capacity

Dinamička / Dynamic	1750 Kg
Raf / Rack	1250 Kg

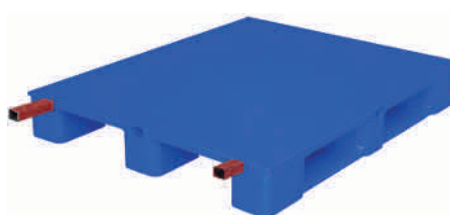

Kapacitet sa 2 metalna profila
2 Metal Profile Capacity

Dinamička / Dynamic	2000 Kg
Raf / Rack	1500 Kg

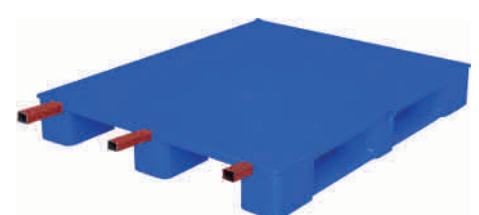

Kapacitet sa 3 metalna profila
3 Metal Profile Capacity

Dinamička / Dynamic	2250 Kg
Raf / Rack	1800 Kg

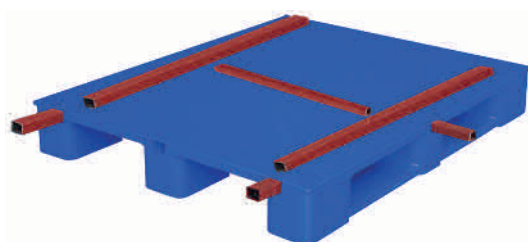

H metalni profil
H Metal Profile

Dinamička / Dynamic	2000 Kg
Raf / Rack	1500 Kg

80-120 MWP, 80-120 MPP, 100-120 MWP
100-120 MPP, 100-120 MWP-5, 100-120-5

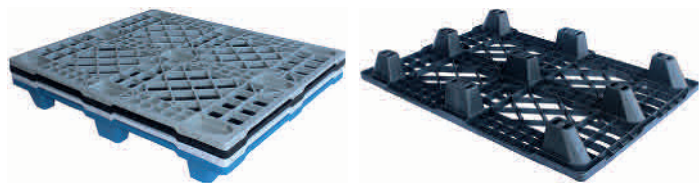

2 Skije / 2 Kunner

3 Skije / 3 Kunner

Raf Kapacitet / Rock Capacity 250 Kg

Raf Kapacitet / Rock Capacity 400 Kg



80-120 XE

800 x 1200 x 130 mm

Statički kapacitet	Dinamički kapacitet	Težina Weight
1500 Kg	400 Kg	4,00 Kg



80-120 XEP

800 x 1200 x 130 mm

Statički kapacitet	Dinamički kapacitet	Težina Weight
1500 Kg	400 Kg	5,20 Kg



100-120 XE

1000 x 1200 x 130 mm

Statički kapacitet	Dinamički kapacitet	Težina Weight
1500 Kg	400 Kg	4,70 Kg



100-120 XEP

1000 x 1200 x 130 mm

Statički kapacitet	Dinamički kapacitet	Težina Weight
1500 Kg	400 Kg	6,20 Kg



80-120 EKO

800 x 1200 x 134 mm

Statički kapacitet	Dinamički kapacitet	Težina Weight
2000 Kg	1000 Kg	7,80 Kg



100-120 EKO

1000 x 1200 x 134 mm

Statički kapacitet	Dinamički kapacitet	Težina Weight
2000 Kg	1000 Kg	10,00 Kg



60-80 A

600 x 800 x 134 mm

Statički kapacitet	Dinamički kapacitet	Težina Weight
1000 Kg	500 Kg	2,50 Kg



80-120 MR
Ugrađeni profili /
Profile Structure

800 x 1200 x 150 mm

Statički kapacitet	Dinamički kapacitet	Raf kapacitet
5000 Kg	1500 Kg	900 Kg
Ažirlik / Weight		
15.00 Kg		



TKZ-39

39 x 390 x 70 mm

80-120-MR Graničnik / Wedges



80-120 Metal
Metalna paleta / Metal Pallet

W L H
800 x 1200 x 145 mm

Statički kapacitet	Dinamički kapacitet
5000 Kg	1500 Kg

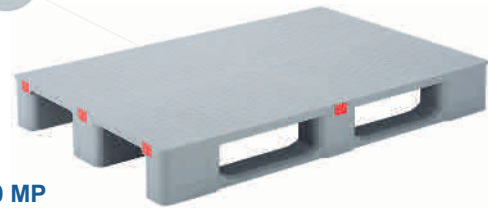
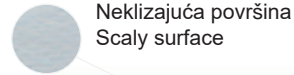

80-120 MP
Neklizajuća paleta
Scoly surface Pallet

W L H
800 x 1200 x 150 mm

Statički kapacitet	Dinamički kapacitet	Raf kapacitet
5000 Kg	1500 Kg	900 Kg
Težina / Weight		15.00 Kg



HP-83X120

W L H

805 x 1270 x 55 mm

80-120 Poklopac palete

Lid for 80-120 Pallet



HP-103X120

W L H

1050 x 1200 x 65 mm

100-120 Poklopac palete

Lid for 100-120 Pallet



VMP-80X120

W L H

800 x 1200 x 355 mm

Metalno telo, hemijska paleta za bačve
Metal body, chemical barrel pallet

Hemijska slavina za odvod
Chemical Discharging nozzle



VPP-80X120

W L H

800 x 1200 x 355 mm

Metalno telo, hemijska paleta za bačve
Metal body, plastic barrel pallet



ESD R-KLT & RL-KLT Kutije
ESD R-KLT & RL-KLT Crates



Ojačana baza
Reinforced Base



Ravna baza
Flat Base

Kod / Code	R-KLT-3115	RL-KLT-3115
Spo / Ext	200 x 300 x 147 mm	200 x 300 x 147 mm
Unu / Int	170 x 245 x 125 mm	170 x 245 x 143 mm
Kod / Code	R-KLT-4115	RL-KLT-4047
Spo / Ext	300 x 400 x 147 mm	300 x 400 x 147 mm
Unu / Int	265 x 340 x 120 mm	265 x 340 x 143 mm
Kod / Code	R-KLT-4122	RL-KLT-4013
Spo / Ext	300 x 400 x 215 mm	300 x 400 x 215 mm
Unu / Int	265 x 340 x 195 mm	265 x 340 x 211 mm
Kod / Code	R-KLT-4129	RL-KLT-4080
Spo / Ext	300 x 400 x 280 mm	300 x 400 x 280 mm
Unu / Int	265 x 340 x 255 mm	265 x 340 x 276 mm
Kod / Code	R-KLT-6115	RL-KLT-6047
Spo / Ext	400 x 600 x 147 mm	400 x 600 x 147 mm
Unu / Int	364 x 544 x 109 mm	364 x 544 x 143 mm
Kod / Code	R-KLT-6122	RL-KLT-6013
Spo / Ext	400 x 600 x 215 mm	400 x 600 x 215 mm
Unu / Int	364 x 544 x 195 mm	364 x 544 x 211 mm
Kod / Code	R-KLT-6129	RL-KLT-6080
Spo / Ext	400 x 600 x 280 mm	400 x 600 x 280 mm
Unu / Int	364 x 544 x 255 mm	364 x 544 x 276 mm



ESD Kutije
ESD crates



HP-4632 ESD

Spo / Ext 400 x 600 x 325 mm
Unu / Int 360 x 560 x 310 mm



HP-4628 ESD

Spo / Ext 400 x 600 x 280 mm
Unu / Int 360 x 560 x 265 mm



HP-4622 ESD

Spo / Ext 400 x 600 x 220 mm
Unu / Int 360 x 560 x 205 mm



HP-4617 ESD

Spo / Ext 400 x 600 x 170 mm
Unu / Int 360 x 560 x 155 mm



HP-4615 ESD

Spo / Ext 400 x 600 x 145 mm
Unu / Int 360 x 560 x 130 mm

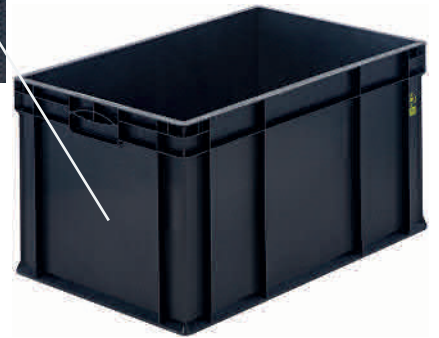

Reljfná površina
Sanded surface

HP-4633 ESD

Spo / Ext 400 x 600 x 340 mm
Unu / Int 360 x 560 x 324 mm



HP-40X60 ESD

Spo / Ext 420 x 600 x 20 mm
400 X 600 mm Poklopac / Lid



HP-41X61 ESD

Spo / Ext 400 x 600 x 10 mm
400 X 600 mm Poklopac / Lid



AX-40x60 ESD

Spo / Ext 400 x 600 x 20 mm
400 X 600 mm Poklopac / Lid



SPR-34X54 ESD

Spo / Ext 340 x 540 x 10 mm
Horizontalni separatori / Horizontal Separates



SPR-5618 ESD
556 x 185 mm



SPR-3618 ESD
356 x 185 mm



SPR-5615 ESD
555 x 150 mm



SPR-3615 ESD
352 x 150 mm



SPR-59 ESD
556 x 90 mm



SPR-39 ESD
356 x 90 mm

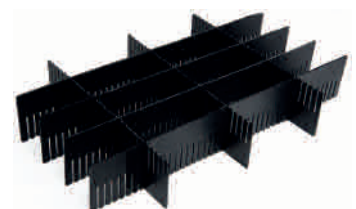



HP-4329 ESD

Spo / Ext 395 x 295 x 290 mm
Unu / Int 365 x 263 x 275 mm



HP-4322 ESD

Spo / Ext 395 x 295 x 230 mm
Unu / Int 365 x 263 x 215 mm



HP-4316 ESD

Spo / Ext 295 x 395 x 174 mm
Unu / Int 263 x 365 x 160 mm



HP-4311 ESD

Spo / Ext 295 x 395 x 117 mm
Unu / Int 263 x 365 x 112 mm



H-3211 ESD

Spo / Ext 200 x 300 x 120 mm
Unu / Int 162 x 262 x 115 mm



HP-20X30 ESD

Spo / Ext 200 x 300 x 10 mm
mm 200 X 300 mm Poklopac / Lid



HP-27-K ESD

Spo / Ext 295 x 505 x 235 mm
Unu / Int 260 x 470 x 217 mm



HP-31X41 ESD

Spo / Ext 303 x 405 x 30
300 X 400 mm Poklopac / Lid



HP-6425-MK ESD

Spo / Ext 400 x 600 x 250 mm
Unu / Int 365 x 543 x 232 mm



HP-6432-MK ESD

Spo / Ext 400 x 600 x 320 mm
Unu / Int 365 x 545 x 302 mm



HP-6435-MK ESD

Spo / Ext 400 x 600 x 360 mm
Unu / Int 365 x 545 x 347 mm



HP-6440-MK ESD

Spo / Ext 400 x 600 x 415 mm
Unu / Int 365 x 545 x 398 mm



HP-4321-ESD

Spo / Ext 300 x 400 x 210 mm
Unu / Int 265 x 340 x 190 mm



HP-4325-ESD

Spo / Ext 300 x 400 x 250 mm
Unu / Int 265 x 340 x 230 mm



HP-4332-ESD

Spo / Ext 300 x 400 x 320 mm
Unu / Int 265 x 340 x 300 mm



HP-4336-ESD

Spo / Ext 300 x 400 x 365 mm
Unu / Int 265 x 340 x 345 mm



80-120 K ESD

Spo / Ext 800 x 1200 x 150 mm

Statiički kapacitet	Dinamički kapacitet	Raf kapacitet
3000 Kg	1000 Kg	600 Kg

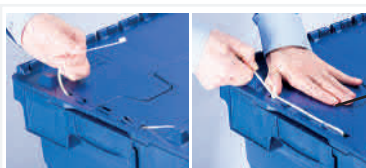

Plastične vezice za bezbedan transport
Plastic cable tie can be applied

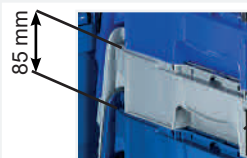

85 mm

Visina slaganja
Nesting height





ESD Plastik Avadanlık Kutular ESD Plastic Stacking Bins



A-400 ESD

Spo / Ext 310 x 490 x 190 mm



A-350 ESD

Spo / Ext 260 x 420 x 170 mm



A-300-ESD

Spo / Ext 215 x 355 x 152 mm



A-250-ESD

Spo / Ext 172 x 305 x 130 mm



A-200-ESD

Spo / Ext 150 x 240 x 122 mm



A-150-ESD

Spo / Ext 125 x 190 x 98 mm



A-100-ESD

Spo / Ext 102 x 170 x 74 mm



SV-419

Spo / Ext 188 x 400 x 80 mm

ESD Plastične fioka kutije ESD Plastic Drawer Boxes



510 ESD

Spo / Ext 260 x 340 x 150 mm
Unu / Int 245 x 331 x 137 mm



501 ESD

Spo / Ext 212 x 306 x 126 mm
Unu / Int 197 x 297 x 112 mm



500 ESD

Spo / Ext 140 x 230 x 98 mm
Unu / Int 125 x 221 x 85 mm



401 ESD

Spo / Ext 120 x 200 x 80 mm
Unu / Int 110 x 197 x 70 mm



351 ESD

Spo / Ext 110 x 170 x 65 mm
Unu / Int 96 x 160 x 55 mm



302 ESD

Spo / Ext 106 x 122 x 62 mm
Unu / Int 102 x 118 x 59 mm



305 ESD

Spo / Ext 106 x 122 x 62 mm
Unu / Int 42 x 118 x 24 mm



102 ESD

Spo / Ext 85 x 120 x 40 mm
Unu / Int 75 x 115 x 35 mm



HP-16 ESD

Spo / Ext 97 x 48 x 48 mm
Unu / Int



CK-400

Kontejner Waste Bins

Spo / Ext.

480 x 530 x 990 mm

Zapremina / Volume

120 Lt.

Kontejneri za otpad sa natpisom
Sticker Labeled Waste Containers



CK-400 STAKLENI OTPAD



CK-400 PAPIRNI OTPAD



ÇK-400 MEDICINSKI OTPAD



ÇK-400 METALNI OTPAD



ÇK-400 PLASTIČNI OTPAD



ÇK-400 OPASNI OTPAD



ÇK-400 GK

ÇK-400 GS

ÇK-400 GM

ÇK-400 GT

ÇK-400 GY

Na sivo telo mogu se postavljati
poklopci različitih boja.
Different colored lids can be applied
on grey body.



25 Lt.

ÇK-20

Spo/ Ext 310 x 350 x 440 mm



40 Lt.

ÇK-30

Spo/ Ext 360 x 390 x 440 mm



65 Lt.

ÇK-65

Spo/ Ext 470 x 400 x 630 mm



85 Lt.

ÇK-85

Spo/ Ext 470 x 450 x 730 mm



ÇK-400 PD

120 Lt.

Spo/ Ext 480 x 530 x 950 mm



240 Lt.

ÇK-500

Spo/ Ext 585 x 730 x 1100 mm



360 Lt.

ÇK-600

Spo/ Ext 620 x 865 x 1100 mm



660 Lt.

ÇK-660

Spo/ Ext 1200 x 780 x 1200 mm



770 Lt.

ÇK-770

Spo/ Ext 1370 x 795 x 1310 mm



1100 Lt.

ÇK-1100

Spo/ Ext 1360 x 1360 x 1330 mm

KANTE ZA OTPAD

WASTE BINS

Mesto za natpis vrste otpada
Waste Type Text

Kante za reciklažni otpad Zero Waste Recycling Bins

Modeli sa nalepticama Models With Stickers



70 Lt.

ÇK-70 W L H
Spo / Ext 402 x 362 x 721 mm



ÇK-70-3 W L H
Spo / Ext 1500 x 362x 721 mm
ÇK-70-3 3' Kante u setu
Zero Waste Bucket Set

Mogućnost spajanja
Coupling pin



Klin za spajanje
Connecting Pin



CP-90-M 90 Lt. W L H 350 x 350 x 710 mm
CP-90-Y 90 Lt. W L H 350 x 350 x 710 mm
CP-90-S 90 Lt. W L H 350 x 350 x 710 mm
CP-90-G 90 Lt. W L H 350 x 350 x 710 mm
CP-90-K 90 Lt. W L H 350 x 350 x 710 mm

PP Valoviti lim debljine 2 mm.

PP nalepnice za kante



ÇK-1812 4' Metalna kanta za otpad-Set / Metal waste bins set
W L H
Spo / Ext 1150 x 300 x 650 mm



ÇK-1811 3' Metalna kanta za otpad-Set / Metal waste bins set
W L H
Spo / Ext 1230 x 420 x 1050 mm



ÇK-1801 Metalna kanta za otpad
Metal waste bin
W H
Spo / Ext 240 x 600 mm
Nerdajuci / Stainless



ÇK-1805 Metalna kanta za otpad
Metal waste bin
W H
Spo / Ext 350 x 1000 mm
Nerdajuci / Stainless



ÇK-1825 4' Metalna kanta za otpad-Set / Metal waste bins set
W L H
Spo / Ext 750 x 320 x 640 mm

PLASTIČNE KUTIJE ZA SLAGANJE

PLASTIC SHELF BINS

Opcije boja/ Color Options



Plava / Blue



Crvena / Red



Siva / Grey

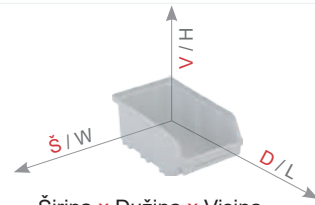

Širina x Dužina x Visina
Width x Length x Height



SV-309

W L H

Spo / Ext 90 x 300 x 80 mm



SV-409

W L H

Spo / Ext 90 x 400 x 80 mm



SV-9 B

SV-309, SV-409 Transparentni separator
SV-309, SV-409 Transparent separator



Baza / Base

SV-309, SV-409
SV-319, SV-419



SV-319

W L H

Spo / Ext 188 x 300 x 80 mm



SV-419

W L H

Spo / Ext 188 x 400 x 80 mm

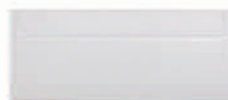

SV-19 B

SV-319, SV-419 Transparentni separator
SV-319, SV-419 Transparent separator

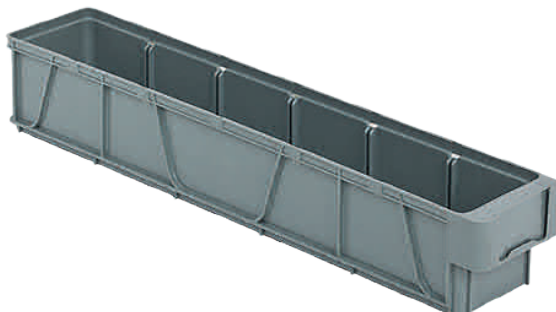

SV-609

W L H

Spo / Ext 115 x 600 x 100 mm



SV-619

W L H

Spo / Ext 230 x 600 x 100 mm



Baza / Base

SV-609, SV-619



SV-609 B

SV-609 Seperator
SV-609 Separator



SV-619 B

SV-619 Seperator
SV-619 Separator



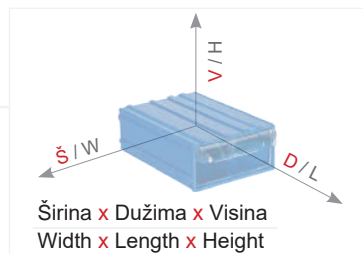

W L H

Spo / Ext 85 x 120 x 40 mm
Unu / Int 75 x 115 x 35 mm



W L H

102 D Spo / Ext 85 x 120 x 80 mm
Unu / Int 75 x 115 x 35 mm



W L H

202 Spo / Ext 100 x 140 x 52 mm
Unu / Int 89 x 130 x 44 mm



W L H

322 Spo / Ext 96 x 140 x 125 mm
Unu / Int 89 x 130 x 58 mm



W L H

132 Spo / Ext 83 x 134 x 103 mm
Unu / Int 74 x 128 x 45 mm



W L H

133 Spo / Ext 83 x 134 x 103 mm
Unu / Int 74 x 128 x 30 mm



W L H

136 Spo / Ext 83 x 134 x 103 mm
Unu / Int 32 x 128 x 29 mm



132, 133 i 136 mogu se međusobno kombinovati

132,133 and 136 can be combined with each other



W L H

141 Spo / Ext 103 x 134 x 83 mm
Unu / Int 92 x 127 x 75 mm



W L H

142 Spo / Ext 103 x 134 x 83 mm
Unu / Int 92 x 127 x 35 mm



W L H

144 Spo / Ext 103 x 134 x 83 mm
Unu / Int 42 x 127 x 35 mm



141,142 i 144 mogu se međusobno kombinovati

141,142 and 144 can be combined with each other



W L H

302 Spo / Ext 106 x 122 x 62 mm
Unu / Int 102 x 118 x 59 mm



W L H

301 Spo / Ext 106 x 122 x 62 mm
Unu / Int 102 x 118 x 25 mm



W L H

305 Spo / Ext 106 x 122 x 62 mm
Unu / Int 42 x 118 x 24 mm



301, 302 i 305 mogu se međusobno kombinovati

301,302 and 305 can be combined with each other

PLASTIČNE FIOKA KUTIJE

PLASTIC DRAWER BOXES



W L H

351 Spo / Ext 110 x 170 x 65 mm
Unu / Int 96 x 160 x 55 mm



W L H

321 Spo / Ext 125 x 140 x 96 mm
Unu / Int 114 x 130 x 84 mm



W L H

325 Spo / Ext 125 x 140 x 96 mm
Unu / Int 56 x 130 x 42 mm



321 i 325 mogu se međusobno kombinovati
321 and 325 can be combined with each other



W L H

390 Spo / Ext 132 x 205 x 63 mm
Unu / Int 120 x 197 x 52 mm



W L H

410 Spo / Ext 132 x 205 x 83 mm
Unu / Int 120 x 197 x 75 mm



W L H

420 Spo / Ext 132 x 205 x 132 mm
Unu / Int 120 x 197 x 124 mm

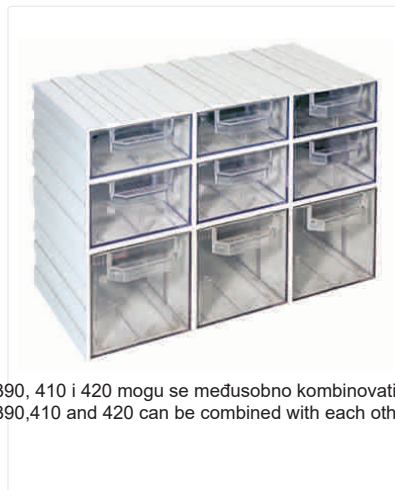

390, 410 i 420 mogu se međusobno kombinovati
390,410 and 420 can be combined with each other



W L H

401-A Spo / Ext 120 x 200 x 80 mm
Unu / Int 110 x 197 x 70 mm



W L H

500-A Spo / Ext 140 x 230 x 98 mm
Unu / Int 125 x 221 x 85 mm



W L H

451 Spo / Ext 173 x 230 x 110 mm
Unu / Int 162 x 220 x 100 mm

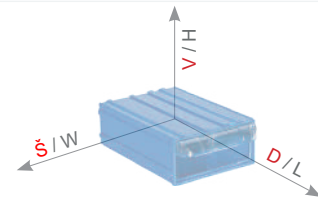

Širina x Dužina x Visina
Width x Length x Height



501-A Spo / Ext 212 x 306 x 126 mm
Unu / Int 197 x 297 x 112 mm



501-2 Spo / Ext 212 x 306 x 126 mm
Unu / Int 94 x 297 x 112 mm



501-D Spo / Ext 212 x 306 x 126 mm
Unu / Int 197 x 297 x 55 mm



501-A, 501-D i 501-2 mogu se međusobno kombinovati
501-A, 501-D and 501-2 can be combined with each other



501-AB Spo / Ext 212 x 306 x 126 mm
Unu / Int 197 x 297 x 112 mm



510 Spo / Ext 260 x 340 x 150 mm
Unu / Int 245 x 331 x 137 mm



510-2 Spo / Ext 260 x 340 x 150 mm
Unu / Int 119 x 331 x 137 mm



512 Spo / Ext 260 x 340 x 150 mm
Unu / Int 245 x 331 x 65 mm



513 Spo / Ext 260 x 340 x 150 mm
Unu / Int 245 x 331 x 43 mm



510, 510-2 i 513 mogu se međusobno kombinovati
510, 510-2 and 513 can be combined with each other



401-3 $\begin{matrix} W & L & H \\ \text{Spo / Ext} & 360 \times 200 \times 155 \text{ mm} \\ \text{Unu / Int} & 110 \times 195 \times 143 \text{ mm} \end{matrix}$



401-3D $\begin{matrix} W & L & H \\ \text{Spo / Ext} & 125 \times 200 \times 155 \text{ mm} \\ \text{Unu / Int} & 110 \times 195 \times 143 \text{ mm} \end{matrix}$



401-6 $\begin{matrix} W & L & H \\ \text{Spo / Ext} & 360 \times 200 \times 155 \text{ mm} \\ \text{Unu / Int} & 110 \times 195 \times 70 \text{ mm} \end{matrix}$



401-6D $\begin{matrix} W & L & H \\ \text{Spo / Ext} & 125 \times 200 \times 155 \text{ mm} \\ \text{Unu / Int} & 110 \times 195 \times 70 \text{ mm} \end{matrix}$



401-9 $\begin{matrix} W & L & H \\ \text{Spo / Ext} & 360 \times 200 \times 155 \text{ mm} \\ \text{Unu / Int} & 110 \times 195 \times 44 \text{ mm} \end{matrix}$



401-9D $\begin{matrix} W & L & H \\ \text{Spo / Ext} & 125 \times 200 \times 155 \text{ mm} \\ \text{Unu / Int} & 110 \times 195 \times 44 \text{ mm} \end{matrix}$



401-4 $\begin{matrix} W & L & H \\ \text{Spo / Ext} & 360 \times 200 \times 155 \text{ mm} \\ \text{Unu / Int} & 170 \times 195 \times 70 \text{ mm} \end{matrix}$

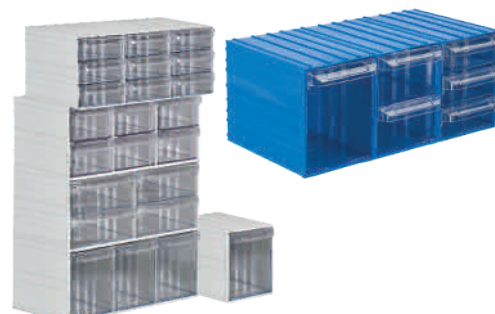

401-3, 401-4 i 401-9 mogu se međusobno kombinovati
401-3, 401-4 and 401-9 can be combined with each other
401-3D, 401-6D i 401-9D mogu se međusobno kombinovati .
401-3D, 401-6D and 401-9D can be combined with each other



450-G Spo / Ext 173 x 230 x 110 mm
Unu / Int 160 x 218 x 100 mm



501-G Spo / Ext 212 x 306 x 126 mm
Unu / Int 193 x 290 x 110 mm

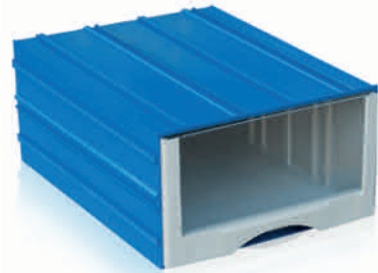

511 Spo / Ext 260 x 340 x 150 mm
Unu / Int 246 x 325 x 135 mm



401-G Spo / Ext 120 x 200 x 80 mm
Unu / Int 110 x 190 x 70 mm



500-G Spo / Ext 140 x 230 x 98 mm
Unu / Int 124 x 217 x 85 mm



451-G Spo / Ext 173 x 230 x 110 mm
Unu / Int 160 x 218 x 100 mm

Pravno obaveštenje
Legal Warning

Registarski broj dizajna: 2007 06461 401-G i 500-G proizvodi; Zaštićen je sertifikatom o registraciji dizajna. Ne može se kopirati ili duplirati.
Br. Registracije dizajna; 2007 06461.

Kodirani proizvodi 401-G i 500-G zaštićeni su potvrdom o registraciji dizajna i ne mogu se kopirati ili reprodukovati



MS-1

MS-1 K

Spo / Ext W L H 100 x 80 x 110 mm
Unu / Int 80 x 70 x 100 mm



MS-2

MS-2 K

Spo / Ext W L H 120 x 110 x 160 mm
Unu / Int 100 x 95 x 145 mm



MS-3

MS-3 K

Spo / Ext W L H 150 x 140 x 205 mm
Unu / Int 125 x 130 x 187 mm



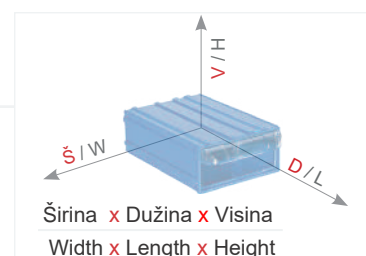

MS-8009 Spo / Ext $W \ L \ H$ 600 x 63 x 80 mm
Unu / Int 60 x 50 x 65 mm



MS-8006 Spo / Ext $W \ L \ H$ 600 x 94 x 112 mm
Unu / Int 94 x 70 x 100 mm



MS-8005 Spo / Ext $W \ L \ H$ 600 x 140 x 164 mm
Unu / Int 110 x 100 x 150 mm



MS-8004 Spo / Ext $W \ L \ H$ 600 x 168 x 208 mm
Unu / Int 140 x 130 x 190 mm



MS-8003 Spo / Ext $W \ L \ H$ 600 x 199 x 240 mm
Unu / Int 190 x 150 x 220 mm



MS-8002 Spo / Ext $W \ L \ H$ 600 x 305 x 354 mm
Unu / Int 285 x 225 x 335 mm



MS-8100				<i>Komada</i>
	<i>W</i>	<i>L</i>	<i>H</i>	<i>Piece</i>
Spo / Ext	610 x 250	1570	mm	48
MS-8009	60 x 50	65	mm	18
MS-8006	94 x 70	100	mm	6
MS-8005	110 x 100	150	mm	10
MS-8004	140 x 130	190	mm	8
MS-8003	190 x 150	220	mm	6



MS-8200				<i>Komada</i>
	<i>W</i>	<i>L</i>	<i>H</i>	<i>Piece</i>
Spo/ Ext	610 x 640	1320	mm	58
MS-8009	60 x 50	65	mm	18
MS-8006	94 x 70	100	mm	12
MS-8005	110 x 100	150	mm	10
MS-8004	140 x 130	190	mm	8
MS-8003	190 x 150	220	mm	6
MS-8002	285 x 225	335	mm	4

PLASTIČNE KUTIJE ZA SLAGANJE

PLASTIC STACKING BINS

Opcije boja / Color Options



Plava / Blue Žuta / Yellow Crvena / Red Siva / Grey

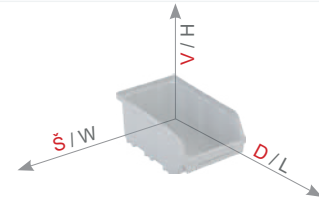

Širina x Dužina x Visina
Width x Length x Height



A-400

Spo / Ext $\overset{W}{310} \times \overset{L}{490} \times \overset{H}{190}$ mm

A-350

Spo / Ext $\overset{W}{260} \times \overset{L}{420} \times \overset{H}{170}$ mm

A-300

Spo / Ext $\overset{W}{215} \times \overset{L}{355} \times \overset{H}{152}$ mm

A-250

Spo / Ext $\overset{W}{172} \times \overset{L}{305} \times \overset{H}{130}$ mm



A-200

Spo / Ext $\overset{W}{150} \times \overset{L}{240} \times \overset{H}{122}$ mm

A-175

Spo / Ext $\overset{W}{125} \times \overset{L}{253} \times \overset{H}{98}$ mm

A-150

Spo / Ext $\overset{W}{125} \times \overset{L}{190} \times \overset{H}{98}$ mm

A-100

Spo / Ext $\overset{W}{102} \times \overset{L}{170} \times \overset{H}{74}$ mm

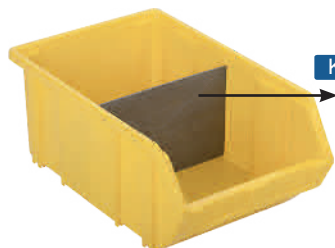

Kod separatora Seperator Kodu

B-300	A-300
B-350	A-350
B-400	A-400



Kod separatora Seperator Kodu

B-400 D	A-400
---------	-------



A-500

Spo / Ext $\overset{W}{490} \times \overset{L}{390} \times \overset{H}{305}$ mm
Unu / Int $\overset{W}{430} \times \overset{L}{325} \times \overset{H}{300}$ mm

A-530

Spo / Ext $\overset{W}{600} \times \overset{L}{400} \times \overset{H}{400}$ mm
Unu / Int $\overset{W}{530} \times \overset{L}{330} \times \overset{H}{395}$ mm

A-530-T

Spo / Ext $\overset{W}{600} \times \overset{L}{400} \times \overset{H}{470}$ mm
Unu / Int $\overset{W}{530} \times \overset{L}{330} \times \overset{H}{395}$ mm

A-500 i A-530 Pruža uštedu prostora slaganjem jedne u drugu. Uz pomoć dodatka mogu se slagati jedna na drugu.

A-500 and A-530 save space while nested. They can also be stacked with optional attachments.

Pravno obaveštenje / Legal Warning

Registarski broj dizajna:: 2007 06461 A-500 i A-530 Zaštićen je sertifikatom o registraciji dizajna. Ne može se kopirati ili duplirati.

Design registration No; 2007 06461. A-500 and A-530 Coded products are protected under design registration certificate and can not be copied or reproduced .



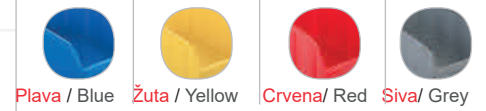

AV-550

W L H

Spo / Ext 340 x 510 x 250 mm



AV-540

W L H

Spo / Ext 340 x 510 x 200 mm

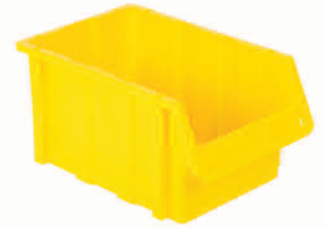

AV-520

W L H

Spo / Ext 255 x 400 x 200 mm



AV-515

W L H

Spo / Ext 255 x 400 x 150 mm



AV-415

W L H

Spo / Ext 175 x 400 x 150 mm

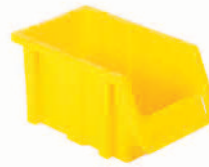

AV-315

W L H

Spo / Ext 175 x 300 x 150 mm

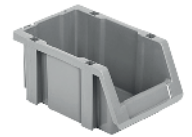

AV-210

W L H

Spo / Ext 130 x 200 x 100 mm



AV-101

Transparentna nalepnica
Transparent Label



AV-102

Klin za nadogradnju
Upgrade Pina



AV-104

Klin za nadogradnju
Upgrade Pina



AV-103

Dodatak za povezivanje
Connecting Pina

Av-540 i Av-550 Može se povezati leđa na leđa..

Av-540 and Av-550 Can be connected back to back.





AV-415

AV-515

AV-520

ST-1050

W L H

Spo / Ext 510 x 400 x 1000 mm

Avadanlık Adedi / Equipment Piece : 13 Adet / Piece



AV-315

ST-1100

W L H

Spo / Ext 700 x 300 x 1150 mm

Avadanlık Adedi / Equipment Piece : 24 Adet / Piece



AV-415

ST-1120

W L H

Spo / Ext 700 x 400 x 1150 mm

Broj komada u setu/ Equipment Piece : 24 Komada / Piece



AV-415

AV-515

AV-520

AV-540

AV-550

ST-1140

W L H

Spo / Ext 1020 x 510 x 1350 mm

Broj komada u setu/ Equipment Piece : 26 Komada/ Piece



AV-415

AV-540

AV-550

ST-1160

W L H

Diş / Ext 680 x 510 x 1100 mm

Broj komada u setu / Equipment Piece : 16 Adet / Piece



AV-515

AV-520

ST-1180

W L H

Diş / Ext 765 x 400 x 1100 mm

Broj komada u setu / Equipment Piece : 15 Adet / Piece



AV-415

AV-540

AV-550

ST-1200

W L H

Spo / Ext 680 x 1020 x 1100 mm

Broj komada u setu / Equipment Piece : 32 Adet / Piece



AV-515

AV-520

W L H

Spo / Ext 765 x 800 x 1100 mm

Broj komada u setu / Equipment Piece : 30 Adet / Piece

PLASTIČNE KUTIJE ZA ALAT

PLASTIC TOOL BOXES



W L H

TK-5034 150 x 290 x 132 mm
Broj komada u setu / In Box : 36 Pcs



W L H

TK-1300 165 x 300 x 135 mm
Broj komada u setu/ In Box :24 Pcs



W L H

TK-1400 175 x 345 x 150 mm
Broj komada u setu / In Box : 24 Pcs



W L H

TK-1600 215 x 400 x 180
Broj komada u setu / In Box :16 Pcs



W L H

TK-1620 213 x 410 x 250 mm
Broj komada u setu / In Box :9 Pcs



W L H

TK-5038 202 x 390 x 235 mm
Broj komada u setu/ In Box : 12 Pcs



W L H

TK-1900 260 x 490 x 240 mm
Broj komada u setu/ In Box : 9 Pcs



W L H

TK-1920 260 x 490 x 320 mm
Broj komada u setu/ In Box : 9 Pcs



W L H

TK-2200 295 x 555 x 265 mm
Broj komada u setu / In Box :7 Pcs



W L H

TK-2220 375 x 570 x 375 mm
Broj komada u setu / In Box :6 Pcs



W L H

TK-2250 260 x 520 x 250 mm
Broj komada u setu / In Box :6 Pcs



W L H

TK-2400 300 x 620 x 282 mm
Broj komada u setu / In Box :6 Pcs



W L H

TK-1700 230 x 410 x 190 mm
Broj komada u setu / In Box :12 Pcs



W L H

TK-2100 255 x 485 x 258 mm
Broj komada u setu / In Box :7 Pcs



W L H

TK-4025 400 x 490 x 180 mm
Broj komada u setu / In Box :4 Pcs



W L H

TK-450-S 358 x 460 x 185 mm
Broj komada u setu / In Box :1 Pcs



W L H

TK-450 358 x 460 x 185 mm
Broj komada u setu / In Box :1 Pcs



PLASTIČNE KUTIJE ZA ALAT

PLASTIC TOOL BOXES



W L H

TK-1310 158 x 325 x 137 mm
Broj komada u setu / In Box :24 Pcs



W L H

TK-1610 213 x 410 x 195 mm
Broj komada u setu / In Box :12 Pcs



W L H

TK-1630 213 x 410 x 250 mm
Broj komada u setu / In Box :9 Pcs



W L H

TK-1910 260 x 490 x 240 mm
Broj komada u setu / In Box :9 Pcs



W L H

TK-1930 260 x 490 x 320 mm
Broj komada u setu / In Box :4 Pcs



W L H

TK-1940 260 x 490 x 256 mm
Broj komada u setu / In Box :9 Pcs



W L H

TK-1950 260 x 490 x 335 mm
Broj komada u setu / In Box :6 Pcs



W L H

TK-2060 283 x 500 x 248 mm
Broj komada u setu / In Box :6 Pcs



W L H

TK-2210 315 x 570 x 295 mm
Broj komada u setu / In Box :6 Pcs



W L H

TK-2230 315 x 570 x 375 mm
Broj komada u setu / In Box :6 Pcs



W L H

TK-2260 300 x 560 x 277 mm
Broj komada u setu / In Box :6 Pcs



W L H

TK-2460 314 x 676 x 300 mm
Broj komada u setu / In Box :4 Pcs



W L H

903 190 x 390 x 170 mm
Broj komada u setu / In Box :12 Pcs



W L H

904 190 x 390 x 215 mm
Broj komada u setu / In Box :16 Pcs



W L H

905 190 x 390 x 260 mm
Broj komada u setu / In Box :20 Pcs



W L H
TK-2500-M 400 x 625 x 420 mm
Broj komada u setu / In Box : 2 Pcs



W L H
TK-2500 400 x 625 x 420 mm
Broj komada u setu / In Box : 2 Pcs



W L H
TK-4026 500 x 725 x 465 mm
Broj komada u setu/ In Box : 1 Pcs
725 x 500 x 465 mm



W L H
TK-5039 330 x 485 x 635 mm
Broj komada u setu / In Box : 1 Pcs
485 x 330 x 635 mm



956 335 x 390 x 62 mm
Broj komada u setu/ In Box : 12 Pcs



955 335 x 390 x 62 mm
Broj komada u setu/ In Box : 16 Pcs



TK-5015 130 x 330 x 250 mm
Broj komada u setu In Box : 6 Pcs



TK-5016 130 x 330 x 250 mm
Broj komada u setu / In Box : 6 Pcs

PLASTIČNE ORGANAJZER KUTIJE

PLASTIC ORGANIZER BOXES



W L H

607 69 x 132 x 25 mm

Pregrada / W/dividers :10 Delova / Part



W L H

605-A 110 x 205 x 45 mm

Pregrada / W/dividers :13 Delova / Part



W L H

606 145 x 255 x 35 mm

Pregrada / W/dividers:18 Delova / Part



W L H

613 145 x 255 x 34 mm

Pregrada / W/dividers :13 Delova / Part



W L H

616 170 x 240 x 55 mm

Pregrada / W/dividers 16 Delova / Part



W L H

TK-2094 100 x 200 x 30 mm

Pregrada / W/dividers 15 Delova / Part



W L H

TK-5017 145 x 215 x 63 mm

Pregrada / W/dividers 3 Delova / Part



W L H

610 170 x 240 x 55 mm

Pregrada / W/dividers :10 Delova / Part



W L H

728 310 x 310 x 37 mm

Pregrada / W/dividers : 28 Delova / Part



W L H

844 190 x 290 x 60 mm

Pregrada / W/dividers :44 Delova / Part



W L H

714 250 x 330 x 55 mm

Pregrada / W/dividers :14 Delova / Part



W L H

724 250 x 330 x 55 mm

Pregrada / W/dividers : 24 Delova / Part



W L H

730 250 x 330 x 55 mm

Pregrada / W/dividers :30 Delova / Part



W L H

951 245 x 325 x 50 mm

Pregrada / W/dividers : 18 Delova / Part



W L H

952 300 x 420 x 60 mm

Pregrada / W/dividers :18 Delova / Part



W L H

953 330 x 480 x 70 mm

Pregrada / W/dividers :18 Delova / Part

PLASTIČNE PROZIRNE KUTIJE ZA SKLADIŠTENJE

PLASTIC STORAGE BOXES



W L H

HP-1 54 x 80 x 23 mm



W L H

HP-2 80 x 120 x 36 mm



W L H

HP-20 65 x 95 x 50 mm



W L H

HP-25 90 x 120 x 50 mm



W L H

P-30 105 x 155 x 65 mm



W L H

HP-35 150 x 205 x 75 mm



W L H

HP-33 123 x 200 x 68 mm



W L H

HP-19 150 x 150 x 40 mm



W L H

HP-15 72 x 72 x 48 mm



W L H

HP-16 97 x 48 x 48 mm



W L H

HP-17 72 x 150 x 48 mm



W L H

HP-36 110 x 150 x 75 mm
Litara / Liters : 0,5 Lt.

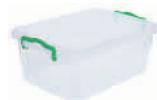

W L H

HP-37 140 x 210 x 75 mm
Litara / Liters : 1,2 Lt.



W L H

HP-39 140 x 210 x 105 mm
Litara / Liters : 1,5 Lt.



W L H

HP-40 165 x 255 x 120 mm
Litara / Liters : 2,8 Lt.



W L H

HP-50 200 x 300 x 135 mm
Litara / Liters : 5,0 Lt.



W L H

HP-55 250 x 375 x 155 mm
Litara / Liters : 9,5 Lt.



W L H

HP-60 310 x 450 x 185 mm
Litara / Liters : 17,5 Lt.



W L H

HP-63 320 x 460 x 290 mm
Litara / Liters : 30 Lt.



W L H

HP-64 390 x 620 x 335 mm
Litara / Liters : 50 Lt.



W L H

HP-65 400 x 600 x 380 mm
Litara / Liters : 75 Lt.



W L H

HP-70 515 x 800 x 420 mm
Litara / Liters : 120 Lt.

PLASTIČNE KUTIJE SA OTVORIMA

PLASTIC MANHOLE BOXES



LOGA 020 200 x 200 x 200 mm
Broj otvora / Connections : 4 Kom / Pcs



LOGA 030 300 x 300 x 300 mm
Broj otvora / Connections : 4 Kom / Pcs



LOGA 032 300 x 300 x 300 mm
Broj otvora / Connections : 6 Kom / Pcs



LOGA 035 350 x 350 x 350 mm
Broj otvora / Connections : 4 Kom / Pcs



LOGA 036 360 x 260 x 320 mm
Broj otvora / Connections : 6 Kom / Pcs



LOGA 040 400 x 400 x 400 mm
Broj otvora / Connections : 4 Kom / Pcs



LOGA 042 400 x 400 x 400 mm
Broj otvora / Connections : 6 Kom / Pcs



LOGA 050 475 x 475 x 465 mm
Broj otvora / Connections : 4 Kom / Pcs



LOGA 055 550 x 550 x 520 mm
Broj otvora / Connections : 4 Kom / Pcs

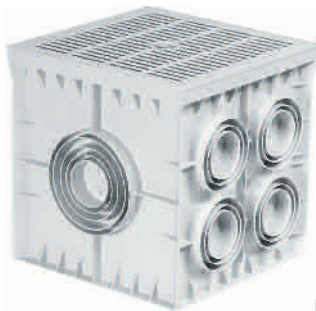

LOGA 056 550 x 550 x 500 mm
Broj otvora / Connections : 10 Kom / Pcs

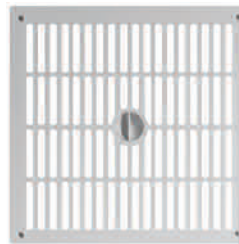

PERFORIRANI SIVI POKLOPAC
PERFORATED GRAY COVER



RAVNI SIVI POKLOPAC
GRAY COVER

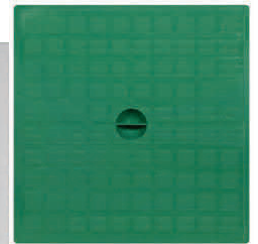

RAVNI ZELENI POKLOPAC
GREEN COVER

POKLOPAC OKVIRA I OKVIRI
MANHOLE COVER AND FRAMES

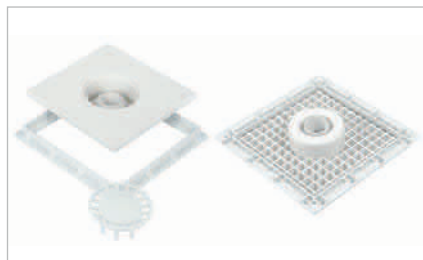

LOGA 120

200 x 200 x 30 mm

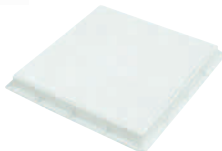

LOGA 130

300 x 300 x 40 mm

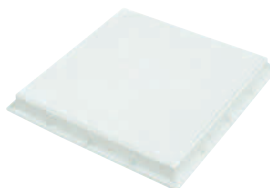

LOGA 140

400 x 400 x 45 mm



LOGA 155

550 x 550 x 65 mm



LOGA 170

700 x 700 x 65 mm

LOGA 130-SG

300 x 300 x 90 mm

LOGA 140-SG

400 x 400 x 90 mm

Saobraćajni čunjevi i stubovi
Traffic Cones And Poles

Znaci i svetlosna signalizacija se mogu pričvrstiti na čunjeve i pontone
Light and boards can be applied



12302 TK 350 x 500 mm
Materijal PPC
Težina / Weight 0,85 Kg



12300 TK 350 x 500 mm
Materijal PPC
Težina / Weight 1,15 Kg



12301 TK 350 x 520 mm
Materijal PPC
Težina / Weight 4,00 Kg
Ponderisana osnova
Ballasted base



12350 TK 370 x 600 mm
Materijal PPC
Težina / Weight 1,50 Kg



12351 TK 350 x 613 mm
Materijal PPC
Težina / Weight 5,15 Kg
Ponderisana osnova
Ballasted base



12401 DB Ø63 x 1000 mm
Materijal PPC-PVC Compuant
Težina / Weight 4,00 Kg



12403 DBR Ø63 x 1000 mm
Materijal PPC-PVC Compuant
Težina / Weight 4,00 Kg



12409 DBR Ø63 x 1000 mm
Materijal PPC-PVC Compuant
Težina / Weight 4,00 Kg



12420 DBR Ø83 x 1100 mm
Materijal PPC-PVC Compuant
Težina / Weight 6,50 Kg



12422 DBR Ø80 x 1100 mm
Materijal PPC-PVC Compuant
Težina / Weight 6,50 Kg



12428 DB
Ø140 x 1200 mm
Materijal PPC - PVC
Težina / Weight 8,70 Kg



12430 DB
Ø140 x 1200 mm
Materijal PPC - PVC
Težina / Weight 8,70 Kg



12402 DB
Ø110 x 1200 mm
Materijal PPC
Težina / Weight 12,00 Kg



12404 DB
Ø110 x 1200 mm
Materijal PPC
Težina / Weight 12,00 Kg



12414 DB
Ø110 x 1200 mm
Materijal PPC
Težina / Weight 12,00 Kg

PVC Fleksibilni saobraćajni ćunjevi i stubovi
PVC Flexible Traffic Cones



12303 TK R1
220 x 320 mm
Težina / Weight 0,65 Kg



12306 TK R1
285 x 500 mm
Težina / Weight 1,30 Kg



12326 TKA R1
385 x 500 mm
Težina / Weight 2,65 Kg
Ponderisana osnova
Ballasted base



12330 TK R1
320 x 520 mm
Težina / Weight 1,25 Kg



12332 TK R1
320 x 520 mm
Težina / Weight 1,25 Kg



12335 TK R1
380 x 700 mm
Težina / Weight 2,30 Kg



12337 TK R2
380 x 700 mm
Težina / Weight 2,30 Kg



12309 TK R2
385 x 750 mm
Težina / Weight 3,20 Kg



12315 TKA R2
485 x 750 mm
Težina / Weight 6,50 Kg
Ponderisana osnova
Ballasted base



12325 TK R2
385 x 900 mm
Težina / Weight 3,60 Kg



12327 TKA R2
485 x 900 mm
Težina / Weight 6,90 Kg
Ponderisana osnova
Ballasted base



126 A
Levha ve Lamba Aparatı
Board and light connector



12270 UBR 1000 x 220 x 455 mm
Materijal PPC Stopa - TPU Znak
Težina / Weight 3,85 Kg



12266 UBR 1000 x 220 x 650 mm
Materijal PPC
Težina / Weight 3,60 Kg

Fiksiranje zavrtnjima Ø18x L90 xØ10 mm.
Zavrtnji i klinovi potrebni za proizvode su uključeni u paket.

Can be fixed to the ground with the Ø18x L90 xØ10 mm screw and wall plug
The necessary screw and wall plug for the related product are in the package.

Fleksibilni obeleživači puteva
Flexible Delineators



12211 UBR	Ø80 x 1000 mm	12212 UBR	Ø80 x 750 mm	12214 UBR	Ø80 x 450 mm	12215 UBR	Ø80 x 300 mm	194 A	
Materijal	TPU	Materijal	TPU	Materijal	TPU	Materijal	TPU	Dodatak za znake i svetlosne znake	
Težina / Weight	1,60 Kg	Težina / Weight	1,30 Kg	Težina / Weight	0,98 Kg	Težina / Weight	0,72 Kg	Board and light connector	



12237 UBR	Ø110 x 750 mm	12243 UBR	Ø90 x 750 mm	12247 UBR	Ø80 x 500 mm	12281 UBR	Ø80 x 700 mm	12283 UBR	Ø80 x 400 mm
Materijal	TPU	Materijal	TPU	Materijal	TPU	Materijal	TPU-PU	Materijal	TPU-PU
Težina / Weight	2,10 Kg	Težina / Weight	1,50 Kg	Težina / Weight	1,00 Kg	Težina / Weight	1,00 Kg	Težina / Weight	0,70 Kg



12255 UBR	120 x 450 mm	12258 UBR	120 x 450 mm	12257 UBR	120 x 750 mm	12256 UBR	120 x 750 mm	12253 UBR	120 x 750 mm
Materijal	TPU	Materijal	TPU	Materijal	TPU	Materijal	TPU-PU	Materijal	TPU-PU
Težina / Weight	950 Gr	Težina / Weight	950 Gr	Težina / Weight	1,40 Kg	Težina / Weight	1,40 Kg	Težina / Weight	1,40 Kg

Mogu se fiksirati na zemlju šrafovim Ø18x L90 xØ10 mm.
Šrafovi i klinovi potrebni za proizvode su uključeni u paket..

Can be fixed to the ground with the Ø18x L90 xØ10 mm screw and wall plug
The necessary screw and wall plug for the related product are in the package.

Znakovi upozorenja, lampe i ogledala
Warning boards, solar flasher lights and mirrors



120 A Ø 280 mm



110 A 390 mm



113 A 300 x 300 mm



114 A 315 x 340 mm



196 A Ø 380 mm



111 A 350 x 410 mm



124 AF Ø 280 mm



295 AF Ø 380 mm



131 AR 390 mm



221 AR Ø 380 mm

Dvosmerni znak / Two-way Warning



11811 FLS



11813 FLK



11827 FLK



11813 FLS



11817 FLK



11819 FLS



11821 FLM

90 X 235 X 290 mm
Dugme za uključivanje
4 + 4 led dioda
upozorenja u dva pravca

Power switch
4 + 4 led two-way warning

90 X 215 X 290 mm
Dugme za uključivanje
8 led dioda
jednosmerno upozorenje

Power switch
8 led single way warning

(ØxH) 128 X 145 MM
6 LED dioda Rotaciono upozorenje
6 led Circular warning



12228 TGA

Ø 600 mm

12226 TGA

Ø 800 mm



12267 TGA

400 x 600 mm

12248 TGA

600 x 800 mm

Materijal PPC - Akriklk Materijal PPC - Akriklk
Težina / Weight 4,00 Kg Težina / Weight 6,00 Kg

Materijal ABS - Akriklk Materijal ABS - Akriklk
Težina / Weight 3,60 Kg Težina /Weight 5,60 Kg



Zahvaljujuci vakumskoj tehnologiji,
Akriлно ogledalo je otporno na UV zrake
Otporno na spoljne uslove.

Acrylic Mirror with Vacuum Technology
Resistant to UV rays and flexible.
Consistent with outdoor conditions.

Zahvaljujuci vakumskoj tehnologiji,
Akriлно ogledalo je otporno na UV zrake
Otporno na spoljne uslove.

Acrylic Mirror with Vacuum Technology
Resistant to UV rays and flexible.
Consistent with outdoor conditions.

Plastične sigurnosne barijere
Plastic Safety Barriers



	L	H
12510 FBR	1500 x 1000 mm	
Materijal	PVC Stope / Feet PPC Tabla / Board	
Težina / Weight	12,30 Kg	

	L	H
12500 FBR	900 x 1500 mm	
Materijal	PVC Stope / Feet PPC Tabla / Board	
Težina / Weight	18,00 Kg	

	W	L	H
12417 DBR	480 x 600 x 900 mm		
Materijal	PVC Stope / Feet PPC Tabla / Board		
Težina / Weight	12,00 Kg		

Obeleživači parking prostora
Car Park Corner Cover



175 A Okov za lanac

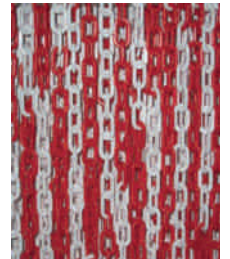

	W	L	H
12292 UBR	90 x 140 x 900 mm		
Materijal	PVC - PE		
Težina / Weight	1,85 Kg		

	W	L	H
12294 UBR	70 x 120 x 800 mm		
Materijal	PVC		
Težina / Weight	1,90 Kg		

	W	L	H
12296 UBR	80 x 120 x 800 mm		
Materijal	PVC		
Težina / Weight	1,90 Kg		

	W	L	H
KZ-1	215x 630 x 340 mm		
Materijal	ABS		
Težina / Weight	1,21 Kg		

	W	L	H
128 A			
Materijal	Crveno beli plastični lanac Red White Plastic Chain		

Pričvršćuje se Ø18k L90 kØ10 mm zavrtnjem. Can be fixed to the wall with the Ø18x L90 xØ10 mm screw and wall plug

Stoperi za vozila
Car Stoppers



	W	L	H
12235 UB	500 x 150 x 100 mm		
Materijal	PPC		
Težina / Weight	1,90 Kg		

	W	L	H
12233 UB	1100 x 150 x 100 mm		
Materijal	PPC		
Težina / Weight	4,25 Kg		

	W	L	H
12231 UB	1800 x 150 x 100 mm		
Materijal	PPC		
Težina / Weight	6,80 Kg		

	W	L	H
12216 UB	500 x 160 x 100 mm		
Materijal	PPC		
Težina / Weight	2,45 Kg		

Pričvršćuje se Ø18k L90 kØ10 mm zavrtnjem. Can be applied to the floor with the Ø18x L90 xØ10 mm screw and wall plug.
Zavrtnji i tipli potrebni za pričvršćivanje proizvoda su uključeni u paket. The necessary screw and wall plug for the related product are in the package.

Oganičivači brzine - "Ležeći policajci"
Speed Bumps



12101 YKK
W L H
250 x 100 x 50 mm
Težina / Weight
0,36 Kg
Materijal : PPC



12102 YK
W L H
300 x 330 x 40 mm
Težina / Weight
1,30 Kg
Materijal : PPC

12103 YKK
W L H
300 x 100 x 40 mm
Težina / Weight
0,25 Kg
Materijal : PPC



12112 YK
W L H
500 x 500 x 45 mm
Težina / Weight
3,10 Kg
Materijal : PPC

12113 YKK
W L H
500 x 250 x 45 mm
Težina / Weight
1,10 Kg
Materijal : PPC

12100 YK
W L H
250 x 350 x 50 mm
Težina / Weight
1,50 Kg
Materijal : PPC



11938 SL
W L H
500 x 500 x 45 mm
Težina / Weight
3,10 Kg
Materijal : PPC
Solarni blic sa 6 Led dioda
Solar Powered Warning Flasher.

11940 SLK
W L H
500 x 250 x 45 mm
Težina / Weight
1,10 Kg



12104 YK
W L H
500 x 330 x 45 mm
Težina / Weight
6,25 Kg
Materijal
Guma PVC
Compoud / Rubber

12105 YKK
W L H
500 x 250 x 45 mm
Težina / Weight
3,00 Kg



12106 YK
W L H
400 x 500 x 40 mm
Težina / Weight
6,50 Kg
Materijal
Guma PVC
Compoud / Rubber

12107 YKK
W L H
400 x 200 x 40 mm
Težina / Weight
1,65 Kg



12109 YKK
W L H
600 x 300 x 45 mm
Težina / Weight
3,40 Kg



12110 YK
W L H
400 x 500 x 40 mm
Težina / Weight
6,50 Kg
Materijal
Guma PVC
Compoud / Rubber

12111 YKK
W L H
400 x 200 x 40 mm
Težina / Weight
1,65 Kg



12291 UBK
W L H
500 x 90 x 60 mm
Težina / Weight
0,70 Kg

12108 YK
W L H
600 x 500 x 45 mm
Težina / Weight
9,30 Kg
Materijal
Guma PVC
Compoud / Rubber

12290 UB
W L H
500 x 500 x 60 mm
Težina / Weight
7,30 Kg
Materijal
Metal PPC

Mogu se međusobno povezati i pričvrstiti za zemlju pomocu vijka Ø18k L90 kØ10 mm i zidnog čepa
Can be connected each other and fixed to the ground with the Ø18x L90 xØ10 mm screw and wall plug for the related product are in the package.

Plastične sigurnosne barijere
Plastic Safety Barriers



Znak upozorenja
Warning flap

	W	L	H
12522 FBR	400	1000	600
Materijal	PPC - PVC		
Težina / Weight	20,00 Kg		



Svetlosno upozorenje
Warning reflector

	W	L	H
12520 FBR	400	1000	600
Materijal	PPC - PVC		
Težina / Weight	20,00 Kg		



Blic upozorenje
Warning flasher

	W	L	H
12526 FBR	400	1000	600
Materijal	PPC - PVC		
Težina / Weight	20,00 Kg		



Graničnik upozorenja
Warning delineator

	W	L	H
12524 FBR	400	1000	600
Materijal	PPC - PVC		
Težina / Weight	20,00 Kg		



Opcije boja

Color Options



Opcije Options



	W	L	H
12423 DB RA	495	395	905
Materijal	PPC - PVC		
Težina / Weight	7,50 Kg		

	W	L	H
12425 DB RA	495	395	905
Materijal	PPC - PVC		
Težina / Weight	7,50 Kg		

Dvosmerno upozorenje /
Two-way Warning



	W	L	H
12424 DB RA	495	395	905
Materijal	PPC - PVC		
Težina / Weight	7,50 Kg		

	W	L	H
12426 DB A	495	395	905
Materijal	PPC - PVC		
Težina / Weight	7,50 Kg		



Žlebasta utičnica
Screwed Socket



Ručke
Handle Grips



Kanal za lanac
Chain Crossing Channel



Ponderisana baza
Ballasted base



Slaganje jedne
na drugu
Nestable



Mogućnost 1
Alternative 1



Mogućnost 2
Alternative 2



Mogućnost 3
Alternative 3

Plastične sigurnosne pregrade
Plastic Safety Barriers

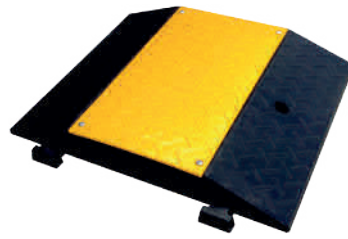

	W	L	H
12298 UB	600	500	75 mm
Materijal	PPC/ PVC		
Težina / Weight	8,70 Kg		



	W	L	H
12299 UB	600	500	75 mm
Materijal	PPC		
Težina / Weight	3,00 Kg		

3 Kanala za provlačenje kablova

Bump and corner with 3 cable channels.

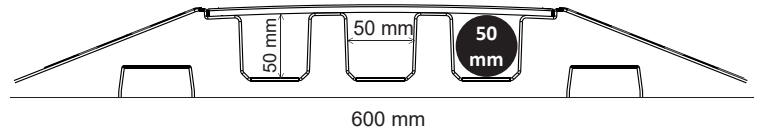
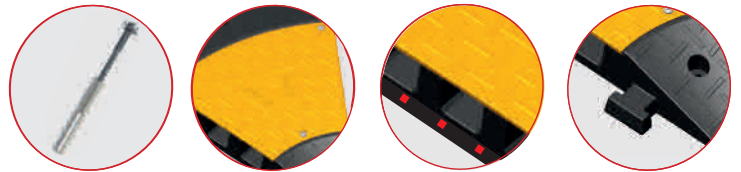
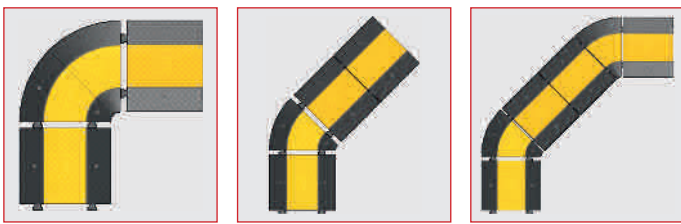

	W	L	H
12203 UBR	1200	150	280 mm
Materijal	PE-PPC		
Težina / Weight	2,50 Kg		



	W	L	H
12204 UBR	1200	150	600 mm
Materijal	PE-PPC		
Težina / Weight	2,70 Kg		



	W	L	H
12207 UBR	260	160	280 mm
Materijal	PE-PPC		
Težina / Weight	0,750 Kg		



	W	L	H
12206 UBR	260	160	600 mm
Materijal	PE-PPC		
Težina / Weight	0,900 Kg		



	W	L	H
12217 UB	1000	200	80 mm
Materijal	PPC		
Težina / Weight	4,10 Kg		



	W	L	H
12262 UB	1000	220	90 mm
Materijal	PPC		
Težina / Weight	3,50 Kg		



	W	L	H
12261 UB	550	150	100 mm
Materijal	PPC		
Težina / Weight	1,90 Kg		



	W	L	H
12263 UB	1100	150	100 mm
Materijal	PPC		
Težina / Weight	4,20 Kg		



	W	L	H
12202 UB	1200	150	50 mm
Materijal	PPC		
Težina / Weight	2,30 Kg		

Drumska signalizacija
Road Markers



12000 YB

W L H
125 x 150 x 32 mm

Materijal PPC

Težina / Weight 0,20 Kg



12002 YB

W L H
120 x 120 x 28 mm

Materijal PPC

Težina / Weight 0,18 Kg



12003 YB

W L H
100 x 220 x 32 mm

Materijal PPC

Težina / Weight 0,24 Kg



12004 YB

W L H
120 x 140 x 25 mm

Materijal PPC

Težina / Weight 0,12 Kg



12005 YB

W L H
105 x 105 x 21 mm

Materijal PPC

Težina / Weight 0,11 Kg



12006 YB

W L H
120 x 220 x 28 mm

Materijal PPC

Težina / Weight 0,22 Kg



12009 YB

W L H
100 x 100 x 21 mm

Materijal ABS

Težina / Weight 0,15 Kg



12007 YB

W L H
120 x 120 x 28 mm

Materijal Aluminium

Težina / Weight 0,29 Kg



12011 YB

W L H
120 x 140 x 21 mm

Materijal Aluminium

Težina / Weight 0,37 Kg



11920 SLK

W L H
125 x 145 x 28 mm

Materijal Aluminium

Težina / Weight 0,45 Kg

Solarni 3+3 Led



11922 SLS

W L H
125 x 145 x 28 mm

Materijal Aluminium

Težina / Weight 0,45 Kg

Solarni 3+3 Led



11924 SLK

W L H
125 x 145 x 28 mm

Materijal Aluminium

Težina / Weight 0,45 Kg

Solarni 3+3 Led



11926 SLS

W L H
125 x 145 x 28 mm

Materijal Aluminium

Težina / Weight 0,48 Kg

Solarni 3+3 Led



11921 SLK

W L H
120 x 135 x 28 mm

Materijal Aluminium

Težina / Weight 0,57 Kg

Solarni 3+3 Led



11923 SLS

W L H
120 x 135 x 28 mm

Materijal Aluminium

Težina / Weight 0,57 Kg

Solarni 3+3 Led

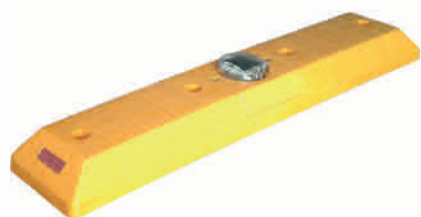

12220 UB

W L H
1000 x 200 x 80 mm

Materijal PPC

Težina / Weight 3,70 Kg

Solarni 3+3 Led



12262 UB

W L H
1000 x 220 x 80 mm

Materijal PPC

Težina / Weight 3,50 Kg

Solarni 3+3 Led

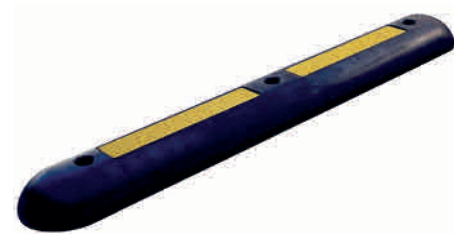

12260 UBR

W L H
1000 x 150 x 60 mm

Materijal PVC

Težina / Weight 6,00 Kg

Reflektujuća traka

Reflective Stripe